

Industrial Wireless Communication

Powerful, rugged, secure

Brochure · April 2012



SIMATIC NET

Answers for industry.

SIEMENS

Industrial Wireless Communication

Forward-thinking solutions for reliable communication

Industrial communication is one of the keys to increasing efficiency, reducing total cost of ownership, and improving productivity. The huge potential, especially of wireless communication, opens up new perspectives here – from partial modernization of plants, right up to optimizing complex logistics or production processes.

Siemens offers solutions for reliable automation with industrial wireless communication based on Wireless Remote Networks, Industrial Wireless LAN, and WirelessHART.

Wireless Remote Networks

Continuous communication between widely separated plant sections in the area of water/wastewater, or high-speed remote maintenance access to machines and plants on the other side of the world - these are just two of the countless ways you can reap the benefits of Wireless Remote Communication. Thanks to integration in the SINAUT telecontrol system or an HMI/SCADA system, transferred process data is available at any time via mobile radio.

Industrial Wireless LAN

Wireless solutions are increasingly becoming a matter of course in machines and plants. In the case of high data communication requirements, Industrial Wireless LAN (IWLAN) backs innovations like deterministic radio and the Industrial Ethernet standard PROFINET.

But IWLAN is also being widely used in industry-oriented applications. The high data transfer rates required there allow applications in association with video streaming as well as the transmission of visualization or language data. High deterministic or redundancy concept requirements can be covered by the IWLAN infrastructure.

WirelessHART

WirelessHART is an open industry standard, developed for the particular requirements of wireless communication at the field level in the process industry. It meets all specific requirements for reliability, security, economy, and user-friendly operation system-wide. With more than 30 million installed devices worldwide, HART technology is the most frequently used communication protocol for intelligent process instrumentation at the field level. WirelessHART is backwards-compatible with wired HART technology and thus offers maximum investment security.

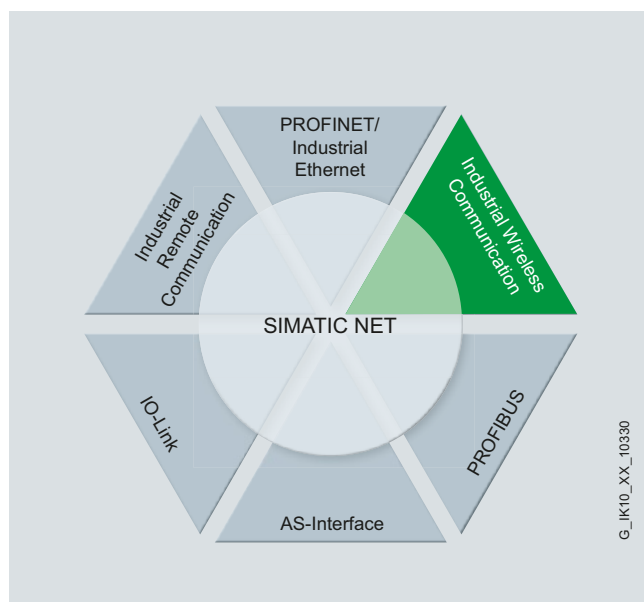

SIMATIC NET – Industrial Communication from Siemens

Industrial communication is of central importance for high-performance automation applications. Its diversity is mirrored in the broad range of industrial communication solutions from SIMATIC NET that extends beyond PROFINET/Industrial Ethernet: With Industrial Wireless Communication, Industrial Remote Communication, PROFIBUS, AS-Interface and IO-Link, it covers all areas of industrial communication. This ensures that the optimum solution is available for every application and every vertical.

IWLAN for industrial and industry-related areas

Powerful, rugged, secure

IWLAN is especially suitable for demanding industrial applications that require end-to-end, reliable and secure radio communication:

- For implementation at industrial and automation customer sites
- For outdoor environments with demanding climatic requirements
- For low-cost integration in the control cabinet or in devices

Integrated communication

Perfectly matched communication products enable smooth operation from the field to the office, from wired PROFIBUS and Industrial Ethernet to the wireless world of Industrial Wireless LAN. This significantly increases the level of effectiveness, since all production and management stations and systems can be used end-to-end.

By connecting an IWLAN access point to the Ethernet network, the latter is expanded by radio functionality. The connection of stations by radio is via their integral WLAN interface, e.g. for a laptop, or via an IWLAN client module to which a station or a further network segment can be connected by cable.

Existing controllers and processes can be accessed without incurring excessive additional cabling costs.

Stations linked by radio can move freely within the range of the Industrial Wireless LAN by using a radio link and the roaming function.



IWLAN for industrial and industry-related areas 3

IWLAN from Siemens 7

IWLAN applications 8

Intralogistics

Maximum flexibility through access to the data communication with the moving unit 8

Automotive production

Communication with moving stations in storage and retrieval systems, conveying routes, production lines, rotating machines, vehicles 10

Crane control

Fast, secure, and error-free communication, high flexibility and plant availability 12

Harbor plant / Container logistics

Integration of an existing infrastructure, and interference-free radio network for automatic guided vehicles 14

Safety-related operation of robots

Automation platform for general purposes 16

Local public transport

Wireless coupling of communication segments for fast startup or low-cost networking 17

Industry-standard products for wireless communication 18

SCALANCE W

- Access points 18

- IWLAN controllers and controller access points . . . 18

- Client modules 19

Antennas and accessories 20

IWLAN RCoax cable 22

Field PG 24

Mobile Panel 277(F) IWLAN 24

ET200pro IWLAN 25

IWLAN/PB Link PN IO 26

Advantages at a glance 27

IWLAN for industrial and industry-related areas

Powerful, rugged, secure

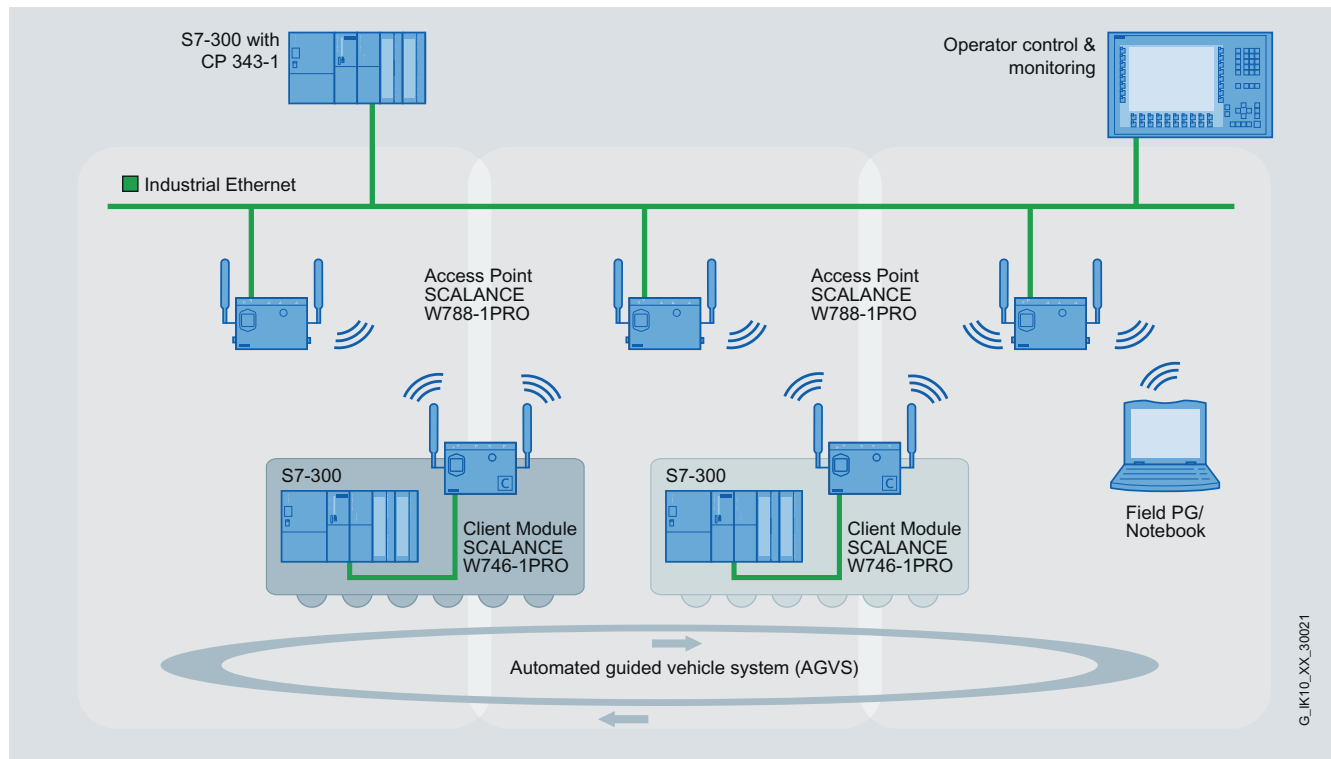

Mobile controls in an automated guided vehicle system

Our industrialized products for wireless communication are characterized by reliability, ruggedness, suitability to harsh industrial environments, and security.

Radio infrastructure

Instead of copper cables and fiber-optic cables, wireless transmission techniques use radio waves. The propagation characteristics of the electromagnetic waves can differ considerably and depend on the surrounding environment and the installed wireless infrastructure.

SCALANCE W modules use techniques such as antenna switchover or diversity, high-quality receivers and fault-tolerant modulation procedures to enhance signal quality and to prevent interruption of radio communication. Extensions to the IEEE 802.11 standard also permit reliable, wireless transmission from PROFINET, form the basis for wireless safety applications and the transmission of video data with extremely short reply and update data.

Network solution with IWLAN

Mobile data terminals, for example, facilitate a continuous information flow from the management level down to the production level.

The IWLAN/PB Link PN IO is available for wireless connection of PROFIBUS devices. This enables fast, wireless, safe, and simple provision of information at the correct location and correct time.



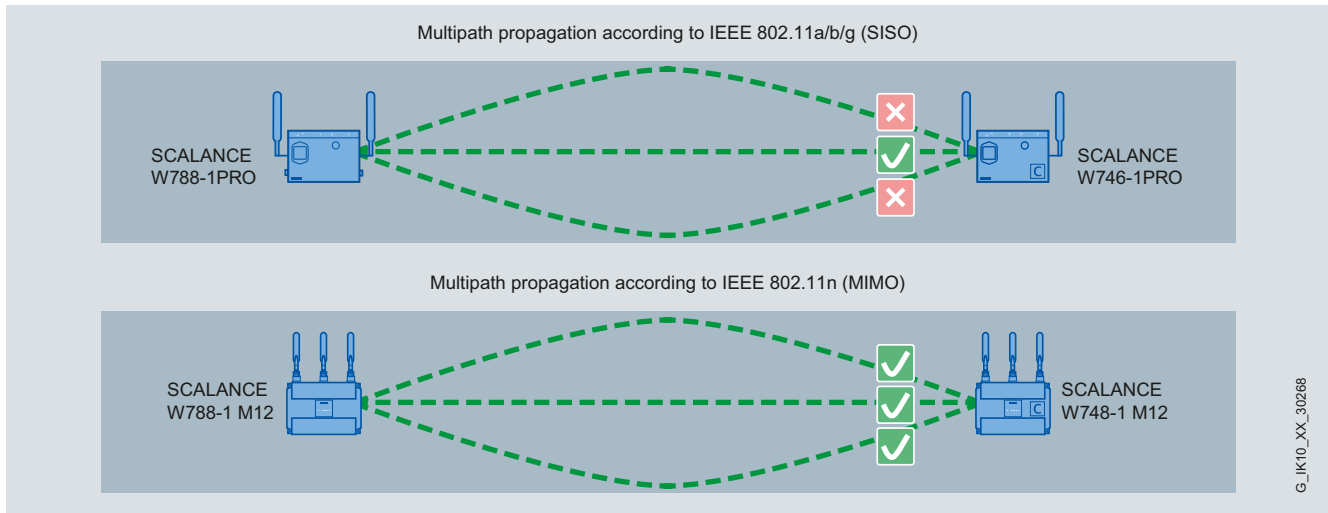

Multiple path propagation (MIMO) with SCALANCE W788-1 M12 and SCALANCE W748-1 M12

Ruggedness and industrial capability

The SCALANCE W products can be exposed to fluctuations in the extended temperature range, or continuous contact with dust and water. Rugged enclosure and construction-based protection against shock and vibration allow use in harsh ambient conditions.

Accessories such as antennas, power supplies and cables are also part of this concept and manufactured in line with industrial requirements.

Power and data are transferred over one cable with Power-over-Ethernet, thus saving investment and maintenance costs.

The swap medium C-PLUG (Configuration Plug) saves engineering and configuration data, making device replacement possible in a short time and without specially trained personnel. This minimizes standstill times and saves training costs.

Reliability of data communication

The international standard IEEE 802.11n makes wireless communication via IWLAN even more robust. The greatest advantage results from the use of multiple path propagation (Multiple Input, Multiple Output (MIMO)). This allows the devices parallel use of multiple antennas. A higher data transfer rate is thus achieved and fault susceptibility in environments with a high number of reflections is reduced.

SCALANCE W products with IWLAN in accordance with IEEE 802.11n support up to three "streams" in the send and receive directions.



IWLAN for industrial and industry-related areas

Powerful, rugged, secure

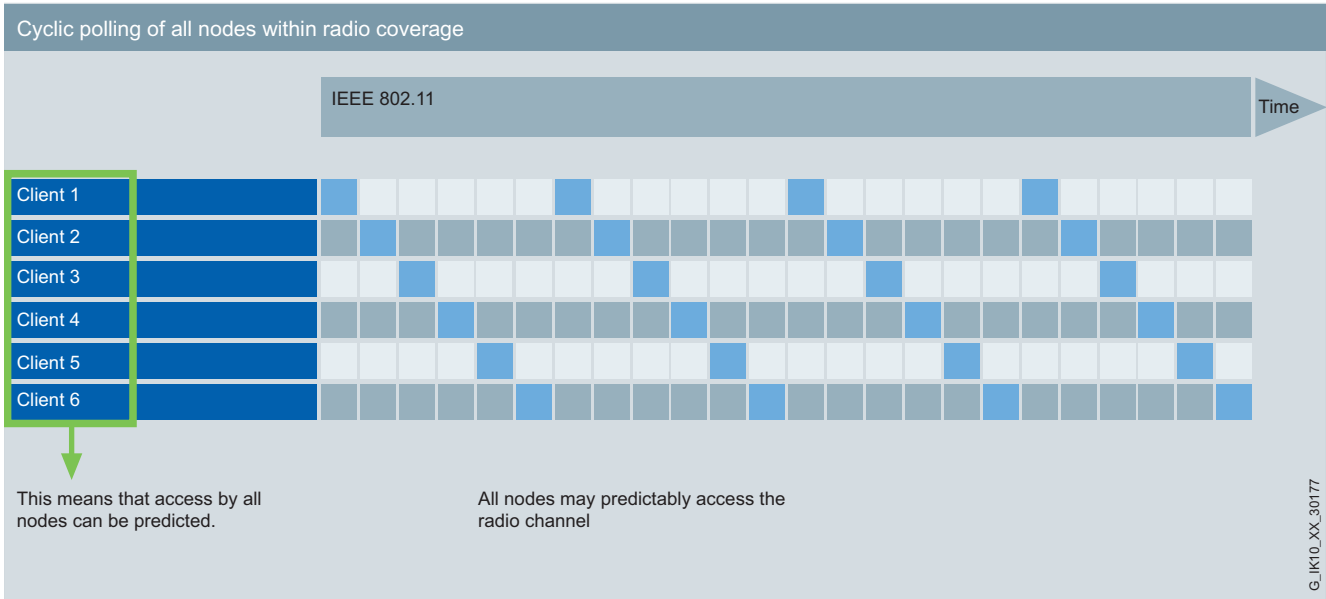

The iPCF function (support from device types with iFeatures) permits cyclic data traffic in real time for several wirelessly linked PROFINET IO devices. In addition, this enables mobile stations to be transferred quickly from one radio field to another (roaming) so that PROFINET IO communication is not interrupted ¹⁾.

Increased transmission rate

WLAN systems in accordance with IEEE 802.11a/b/g/h use a single channel for sending and receiving data. This achieves a maximum gross transmission rate of 54 Mbit/s.

Two channels are used simultaneously with the help of channel bonding. Gross transmission rates of up to 450 Mbit/s can be achieved in conjunction with MIMO technology in accordance with IEEE 802.11n.

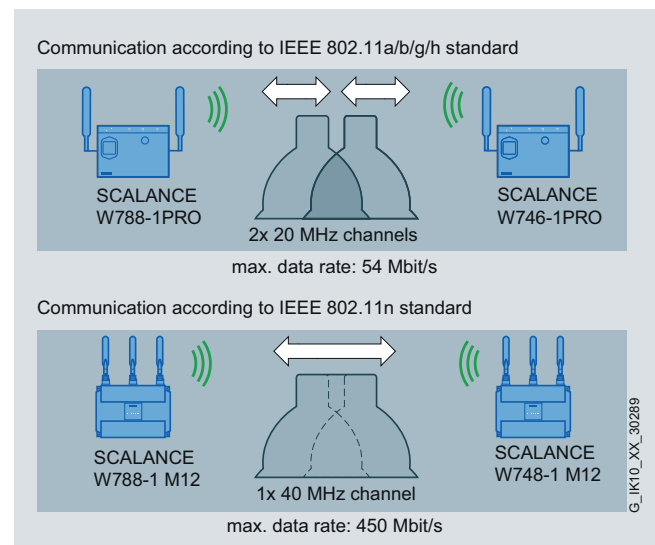

Increased transmission rate on IWLAN in accordance with IEEE 802.11n with the help of channel bonding

1) Available soon for IEEE 802.11n compliant products

IWLAN from Siemens

Powerful, rugged, and secure

Thanks to the use of mobile devices linked via wireless data networks (e.g. wireless LAN), the efficiency of processes can be significantly improved. The primary benefit of wireless solutions is the simple and flexible availability of mobile or hard to access stations.

Mobile communication increases a company's competitiveness, as it helps achieve greater flexibility through the use of wireless communication to automation devices and industrial terminal devices. As a result you can simplify maintenance work, reduce service costs and downtimes and deploy your personnel optimally.

Industrial Wireless LAN (IWLAN) is based on the WLAN standard IEEE 802.11 and provides extensions that are particularly suited to demanding industrial applications with real-time and redundancy requirements. Customers are thus provided with a single wireless network for both process-critical data and uncritical communication.

SCALANCE W products are characterized by the reliability of their radio channel and the rugged type of construction with high requirements with respect to mechanical durability for which SIMATIC is known. To protect against unauthorized access, the products provide modern standard mechanisms for user identification (authentication) and encryption of data, and can at the same time be easily integrated into existing security concepts. These are based on international standards in accordance with IEEE 802.11 at 2.4 GHz and 5 GHz, and data transfer rates of up to 450 Mbit/s.



IWLAN applications

Intralogistics

Task specification

- Manufacture of high-quality steel from scrap metal for the automotive, machine construction, and appliances industries
- Processing of approx. 600 000 tonnes of scrap metal per year
- Use in extremely harsh environments
 - Production of smoke and dust
 - Exceptionally high temperatures
 - Strong vibrations
- Optimum positioning/locating of antennas since the entire building contains steel, e.g. cranes, racks, doors, assembly lines
- Ensured reliability of motion sequences in the process
- Assured production continuity and quality

Demands placed on all electronic controls and components:

- Maximum reliability even under difficult conditions; a failure could have devastating effects on productivity and safety



Solution

Wireless monitoring of the scrap metal vehicles:

- Wireless data transfer between the conveying equipment and the control system
- Monitoring of transport and feeding of the track-based scrap metal vehicles – exact determination of usage/ storage of more than 10 types of scrap

Classical crane control:

- Reliable wireless data transmission
- Determination of exact position of factory crane in order to optimize movements and routes

Benefits

- Fast and secure data transfer:
The quality of the radio signals which reach the control system's receiver despite the harsh ambient conditions is so high that further protection of the radio data can be omitted



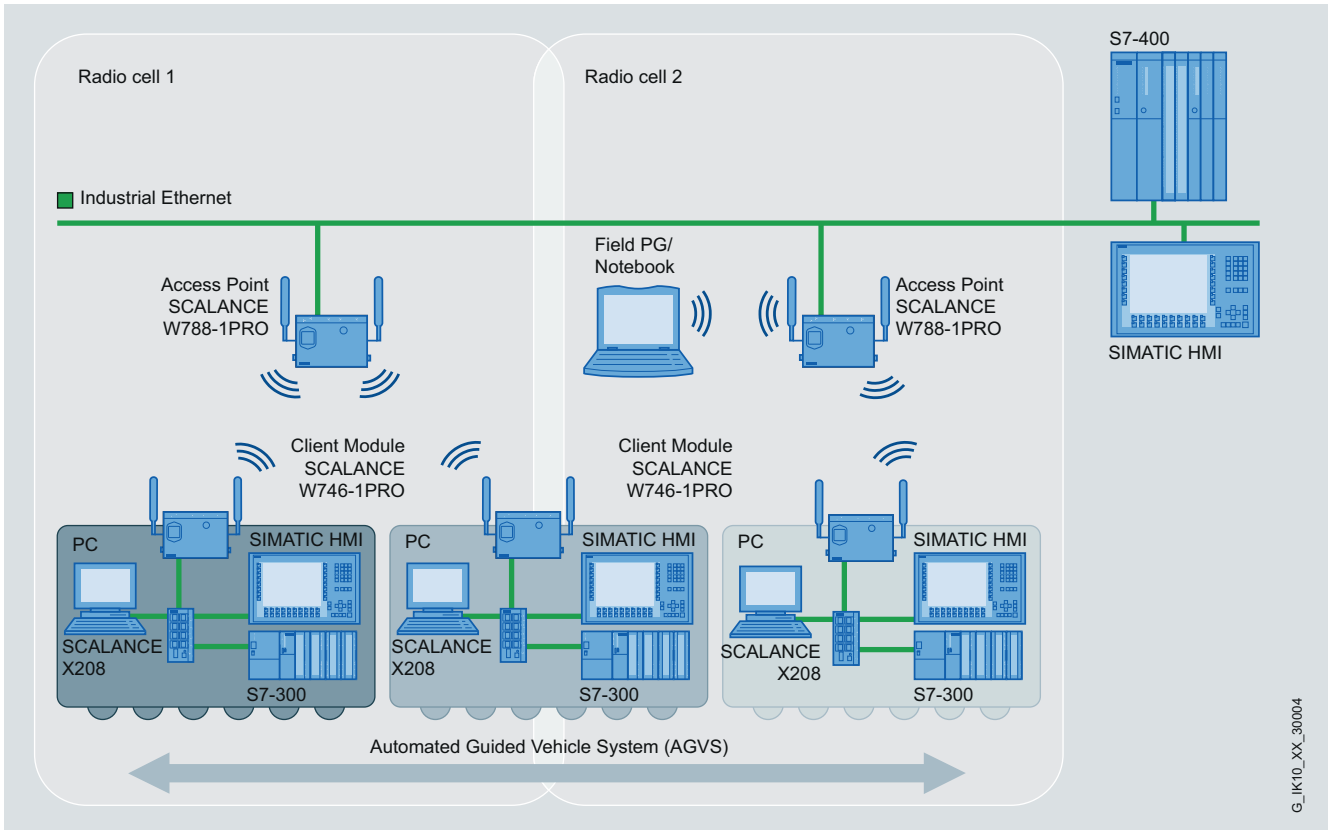

G_IK10_XX_30004

Roaming of moving units (e.g. Field PG and mobile controller) in a radio network with two access points

IWLAN applications

Automotive production

Task specification

- The number of nutrunners used in vehicle final assembly should be reduced. The existing solution uses one nutrunner for each cycle and each barcode detection
- Since the hard-wired solution with slip rings results in high maintenance costs, a reliable wireless communication solution is required to increase efficiency and reduce setup times
- The products should be industrialized and available worldwide
- Investment protection is also required by ensuring the long-term availability of the components used

Solution

- The IWLAN RCoax Cable – a silicon-free radiating cable – is used along the coding rail to enable wireless data transfer. It generates a defined conical and reliable radio field, which is easy to route. The RCoax Cable is therefore ideal for use in demanding radio environments and in all types of rail-mounted vehicles.
- IWLAN access points with data transfer rates up to 54 Mbit/s are used as the supply station for the RCoax cable.
- By using the client module as a mobile station, the same mobile unit can be used for all applications, and consequently one mobile nutrunner can be employed for multiple cycles.

Benefits

- Low investment costs owing to the reduced number of nutrunners
- Reduction in maintenance costs and downtimes thanks to a reliable wireless and wear-free data transfer to mobile communication partners
- Increased plant availability thanks to reliable, contactless transmission of power and data
- Reduction of operator activity, for example scanning, cycle transfer, travel time allows higher throughput
- Easy to change models, dependent only on material logistics
- Possibility of integrating additional quality assurance applications
- Complete nutrunner data can be loaded via the IWLAN line



System solution for nutrunner controllers with RCoax Cable and SCALANCE W747-1RR

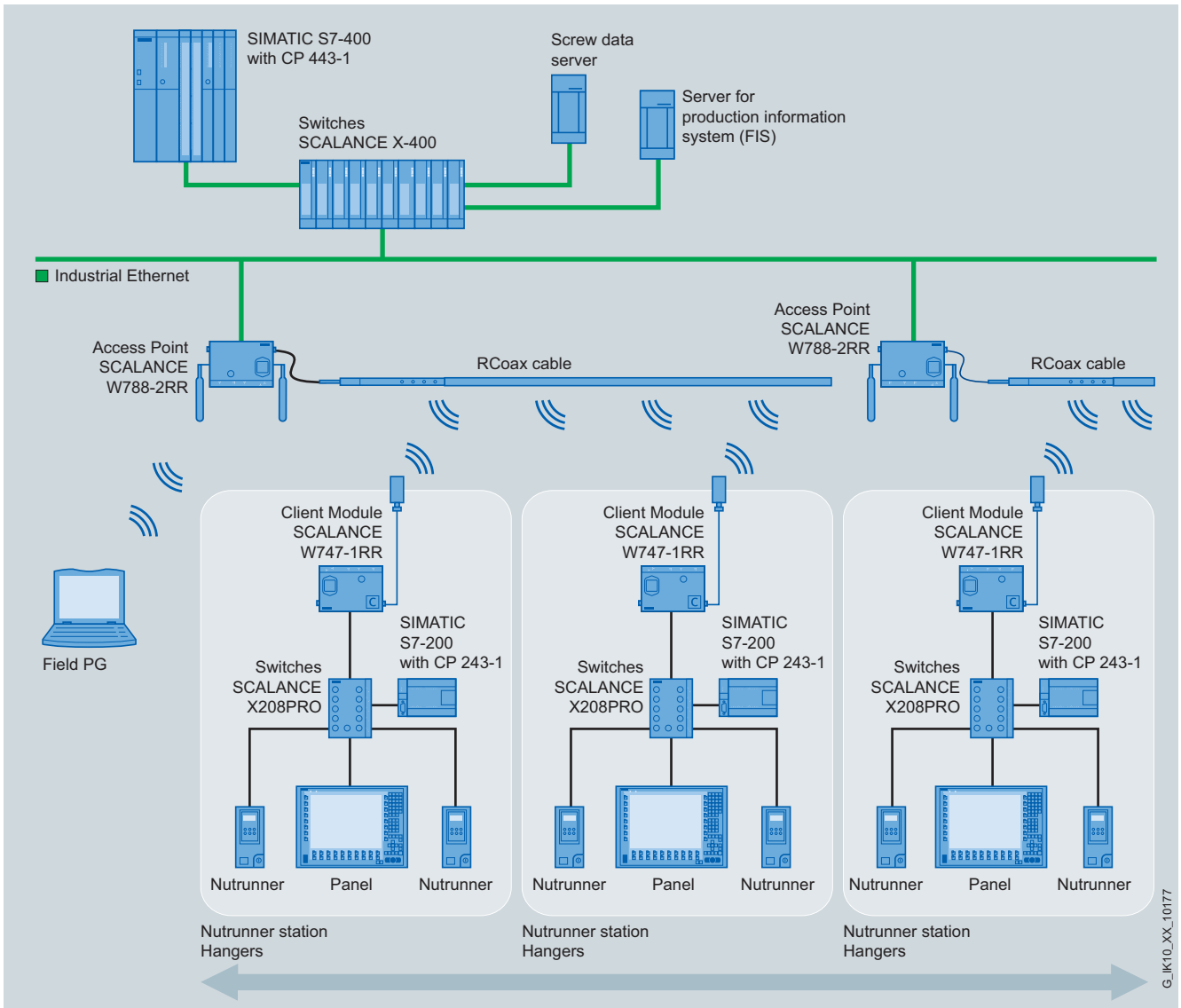

Configuration example with RCoax cable using example of a nutrunner control in automobile production

G_IK10_XX_10177

IWLAN applications

Crane control

Task specification

- Safe and reliable transport system in harsh environment
- Cost-effective solution
- Reduced maintenance outlay
- Fast installation and startup
- Simple connection to the control and MES levels
- The solution should be reliable and high-performing and offer high availability

Solution

- Wireless connection of two automated transport cranes
- Wireless communication with two automated guided vehicles (AGV)
- IO controller and IO devices on the mobile units
- Industrial Ethernet for the network infrastructure
- HMI devices on mobile units on site

Benefits

- High flexibility and plant availability
- Fast installation and commissioning thanks to reliable Industrial Wireless LAN components
- Simple connection to the control and MES levels



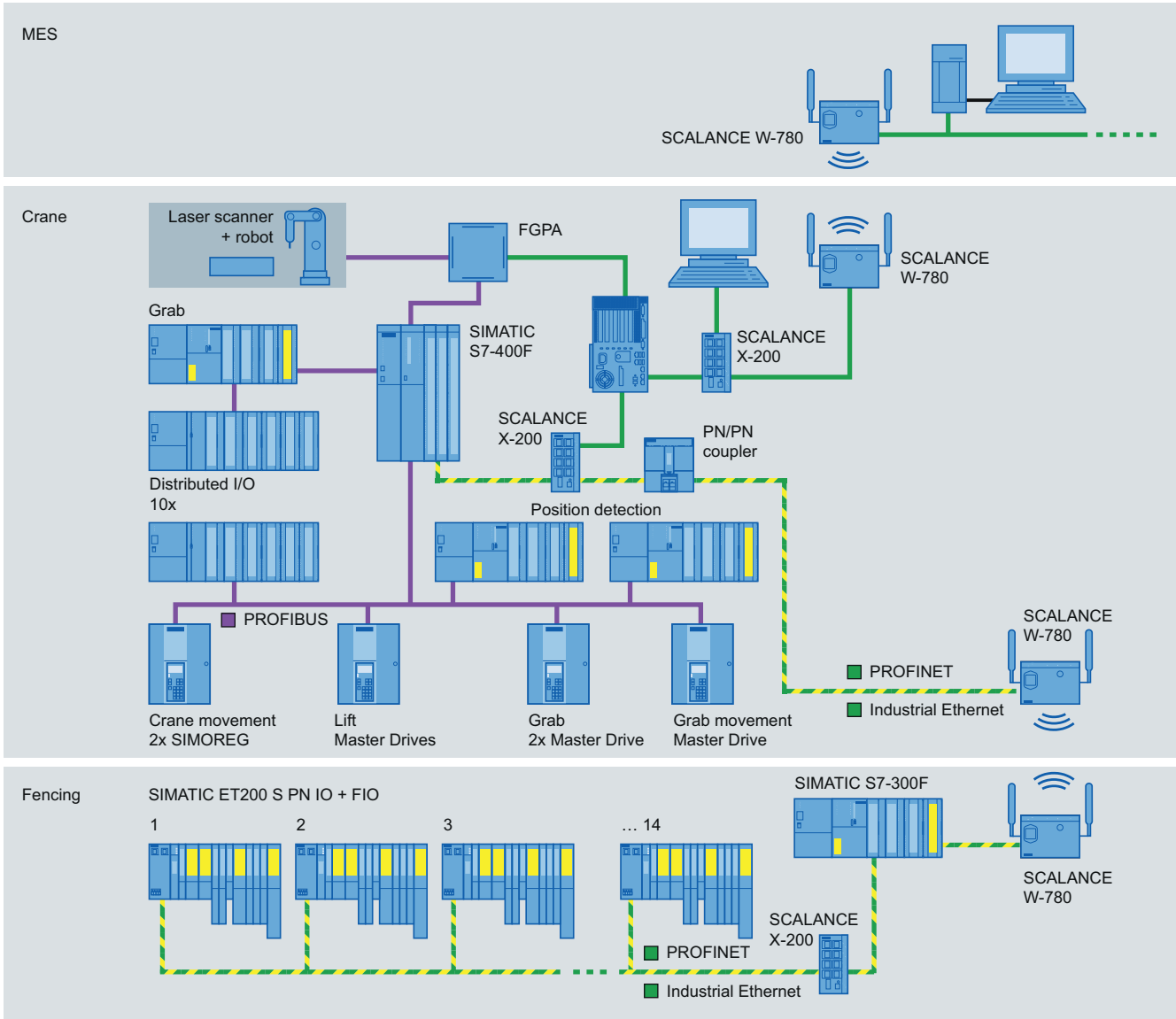

Automated crane control with SCALANCE W

IWLAN applications

Harbor plant / Container logistics

Task specification

- A rugged radio system should be installed for outdoor use in a container handling system at the port of Hamburg. It should be possible to load and unload containers via IWLAN using automated guided vehicle systems (AGV). Both the driving area and the lanes between the storage blocks should be inspected reliably and economically, the system should be expandable and be insensitive to interference even as the number of vehicles rises.
- The system should be reliable and work together with other networks that are already in place, as the changeover to the new system can only take place step by step.
- Solid, expert support should be provided by the manufacturer during implementation and installation.

Benefits

- Interference-free operation thanks to the excellent functioning of the radio network.
- Savings in costs, as the existing infrastructure (masts and antennas) could be retained
- Easy operation and configuration of all access points through the use of IWLAN controllers
- Targeted on-site support during implementation and commissioning
- Expandable radio network for further investments in the future

Solution

- For the coverage of the driving area and lanes in-between, SCALANCE W access points are used to operate 54 automated guided vehicles (AGV), guaranteeing optimum coverage of the radio area involved.
- The radio network is based on the IEEE 802.11 standard and is therefore reliable and free from interference. The roaming function enables the automated guided vehicle systems to move freely within the radio field.
- Coordination with existing networks was already taken into consideration during advance planning, and successfully put into practice.

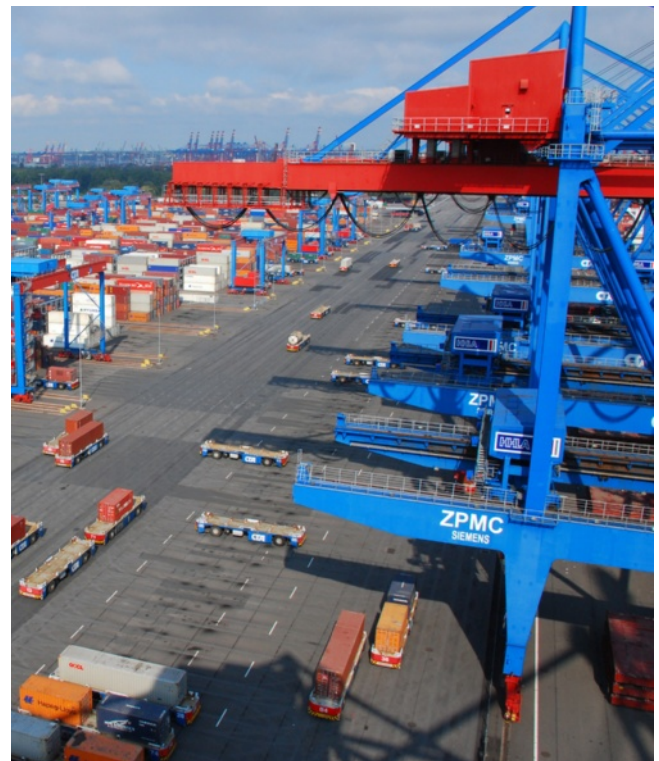

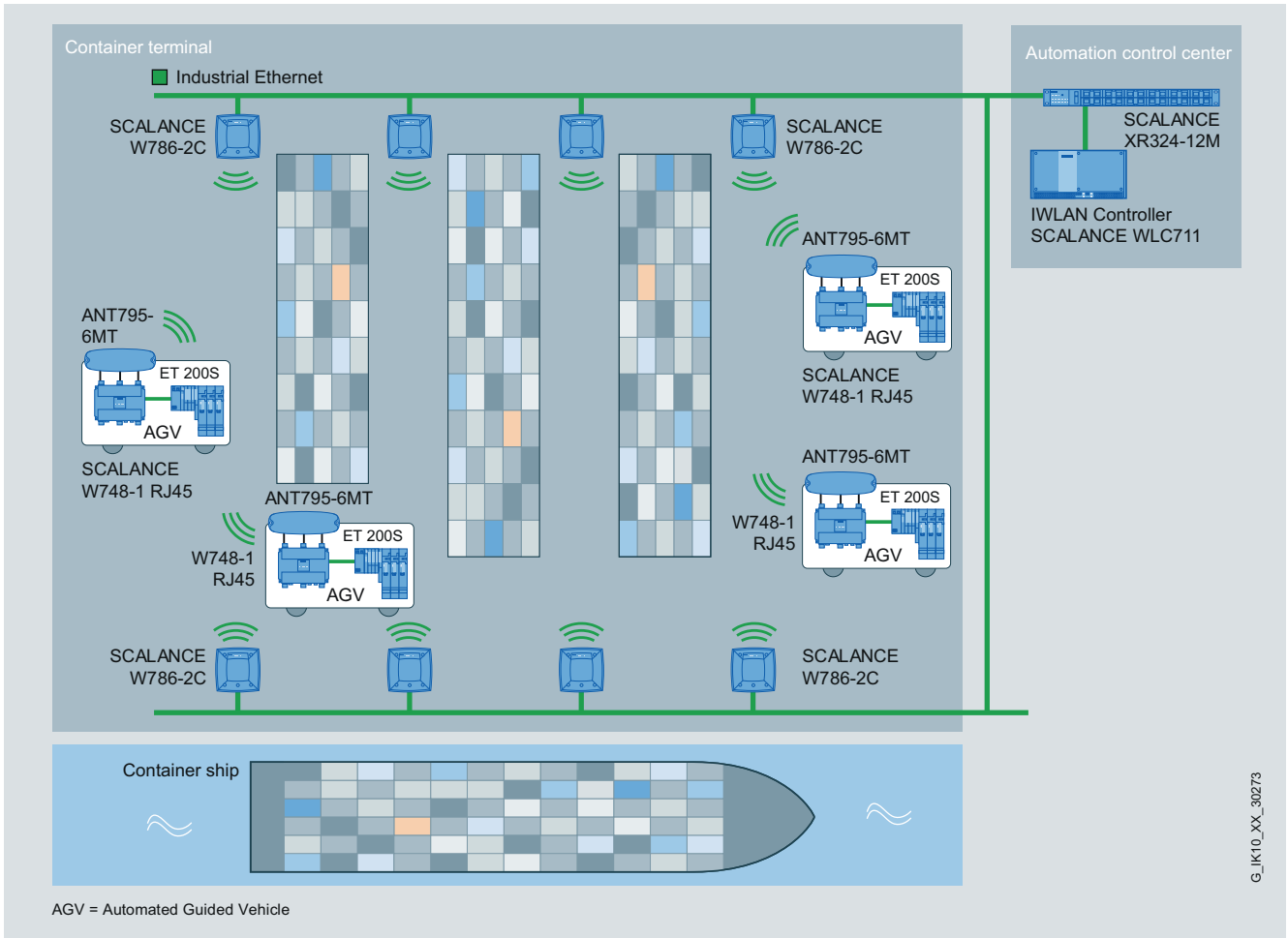

Application example for controller-based IWLAN applications with a large number of access points, e.g. in a container terminal

IWLAN applications

Safety-related operation of robots

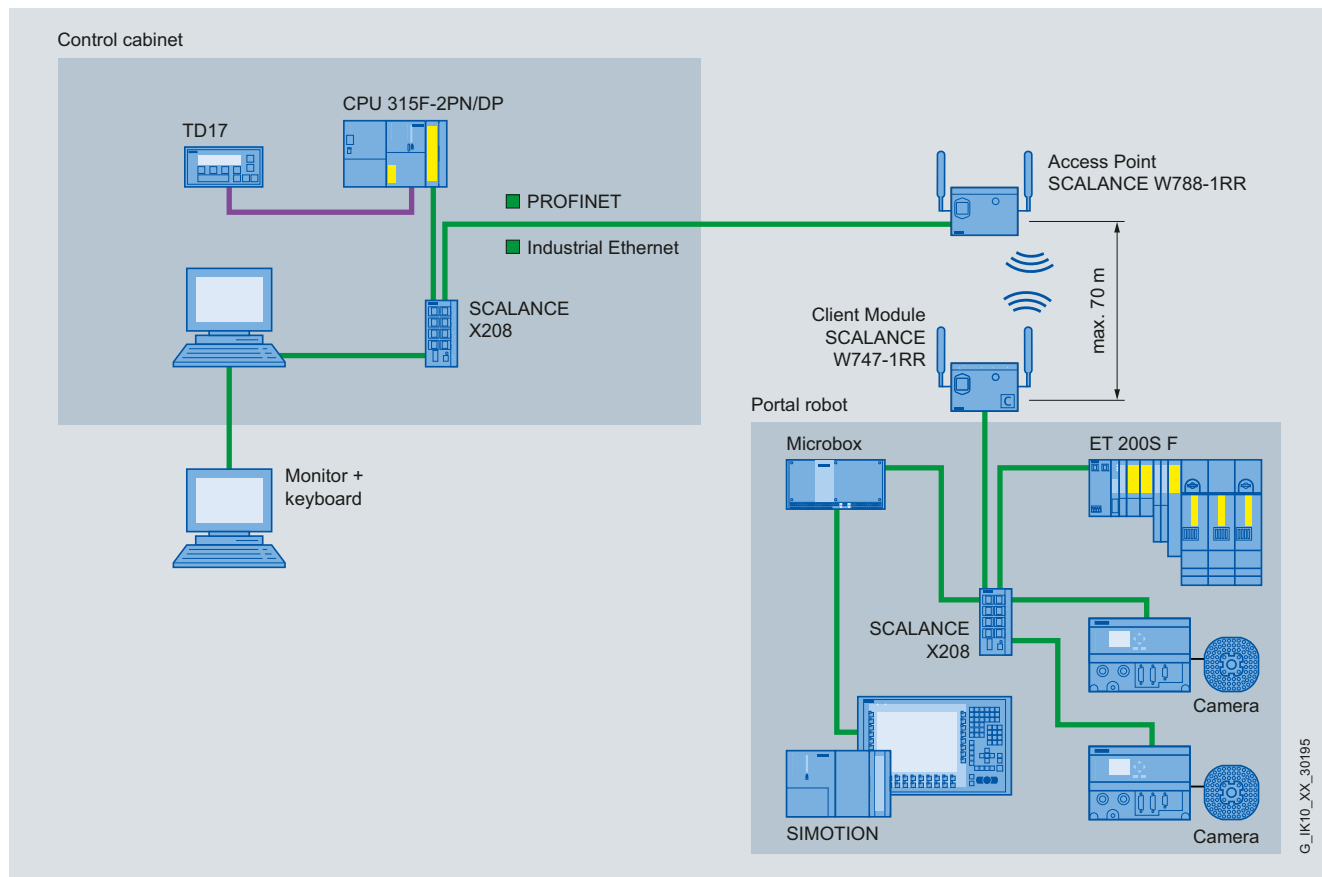

Safety over Wireless in a gantry robot

Task specification

- In the production of visually guided gantry robots, a scalable, expandable automation platform should be established for general tasks, such as palletizing and depalletizing heavy goods at high speed and with high precision
- The aim is to significantly cut installation and commissioning costs, as large distances have to be covered in the plant
- Commercially available components should be used to achieve the solution
- A wireless, open and user-friendly safety system should be installed

Solution

- To achieve the solution, a single network is established for standard and safety data
- SCALANCE W access points with rapid roaming function are used
- An integrated engineering support environment is installed

Benefits

- Easier operation due to the use of a single network for all applications (image processing, safety, peripherals, motor control)
- Wireless and safety components are contained in a single network, simplifying engineering and diagnostics
- Cabling costs are cut by 30%, installation time is reduced and commissioning is facilitated

Equipment for the public transport system

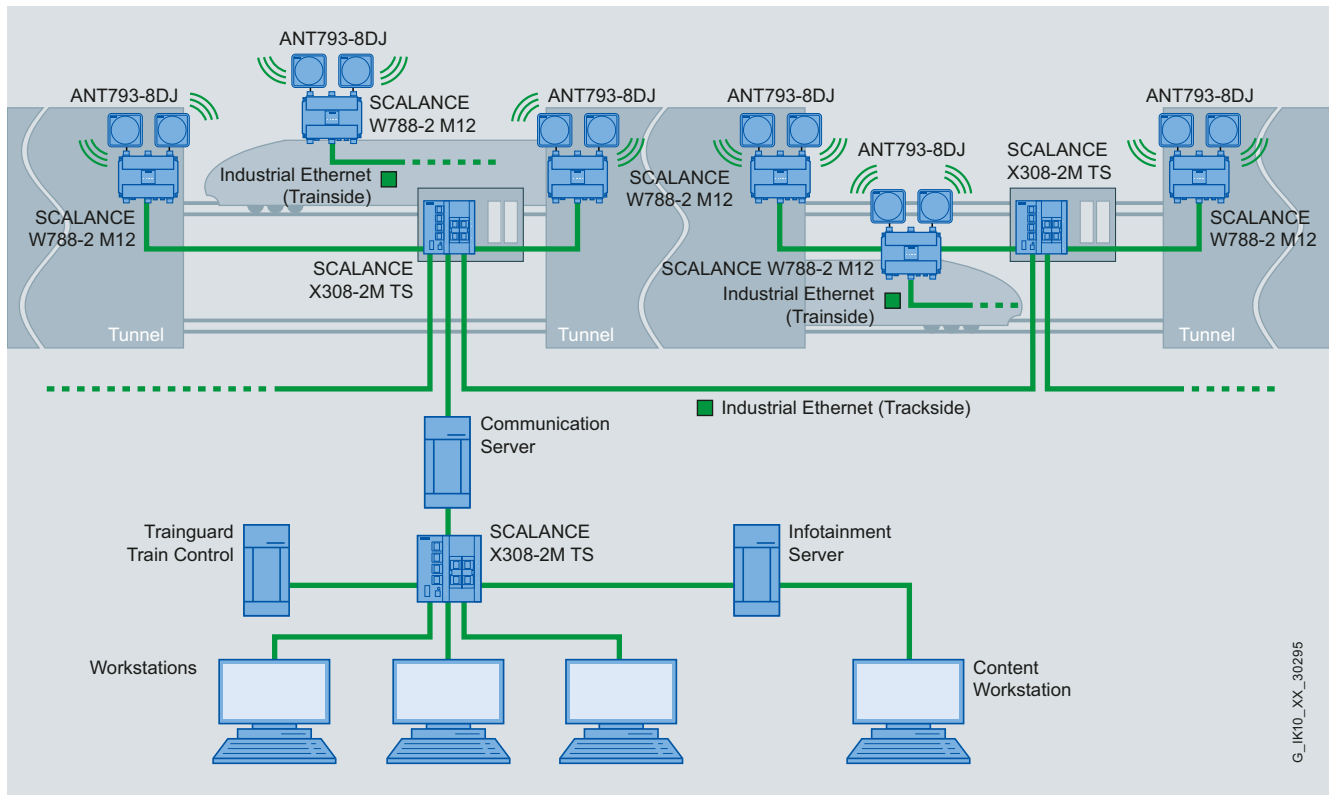

Data transfer in trains with SCALANCE

Task specification

Bidirectional transmission of data

- Out of the train: Live streams of video monitoring (CCTV), passenger counting, ticketing, telemetry etc.
- Into the train: Real-time IPTV, infotainment, WLAN hotspot
- Control of up to 32 access points per tunnel, and additional redundancy if a controller fails

Solution

Implementation of train-to-trackside coupling using broadband WLAN

- Installation of a WLAN infrastructure along the route/track
- Equipping trains with switches and WLAN clients (dual-client)
- Two SCALANCE WLC711 Industrial Wireless LAN controllers with expansion license for up to 32 access points each are used per tunnel and configured for redundant operation. This means that a controller can monitor up to 64 access points.

Benefits

- Extremely rugged IWLAN products, which are unaffected by shaking and jolting and can be used in a broad temperature range of -20 °C to +60 °C
- The radio network's excellent functioning and IEEE 802.11b (11 Mbit/s) radio standard ensure interference-free operation
- SCALANCE W products are standard products
- Siemens guarantees that spare parts will be kept in stock for 10 years



Industry-standard products for wireless communication

SCALANCE W

The radio connection with Industrial Wireless LAN (IWLAN) in accordance with IEEE 802.11 and iFeatures such as iPCF offers such high performance that it can even meet the strict real-time requirements of PROFINET IO – even in demanding industrial environments.

Access points

The access points of the SCALANCE W780 product line are ideally suited for setting up Industrial Wireless LANs (IWLAN) for 2.4 GHz or 5 GHz. They can be used in all applications that require a high degree of operational reliability, even in extremely harsh ambient conditions.

- High data rates (up to 450 Mbit/s in conjunction with channel bonding) with 3x3 MIMO technology (Multiple Input, Multiple Output); here, SCALANCE W access points use three streams each for simultaneous transmission and reception
- Suitable for any application:
 - For installation in the control cabinet
 - For indoor installation without a control cabinet
 - For outdoor environments with demanding climatic requirements
- Reliable thanks to rugged, impact-resistant housing, protected from water and dust (IP65), resistant to shock, vibration and electromagnetic fields
- Complex applications with redundancy requirements and high bandwidths, e.g. for video, by using IEEE 802.11n
- Configuration support by means of wizards and online help; easy management via Web server and SNMP
- Fast replacement of devices in event of failure by means of optional C-PLUG (Configuration Plug) swap medium



IWLAN controller and controller access points

Fundamental principles of the controller-based Industrial Wireless LAN

The IWLAN controller enables centralized management of an Industrial Wireless LAN. It automatically detects new access points, establishes a connection to them, and manages and coordinates access points and clients. This function allows wireless expansion of an Ethernet network without having to make changes to the existing network topology.

The IWLAN controller connects, manages and coordinates all access point and clients such that the WLAN environment appears like several IP subnetworks with central management. The individual connections are additionally managed here, and the stations can therefore move securely and reliably throughout the entire radio network.

With the IWLAN controller, the IWLAN wireless infrastructure can be divided into logical, service-based networks (Virtual Network Services). Different services, security requirements and access criteria can thus be reliably managed, and different user groups such as administrators, commissioning engineers, or visitors can use the same wireless network.

For optimum capacity utilization of the IWLAN network, different applications such as Voice-over-IP (VoIP), video, and Internet access can use the same infrastructure.

Diagnostics and management functions

















As well as centralized management and wireless network configuration, the WLC711 IWLAN controller also offers error recording, wireless network monitoring, and documentation of network statistics.



Client modules

The Client Modules from the SCALANCE W740 product line are optimal for integrating Industrial Ethernet stations into Industrial Wireless LANs (IWLANs) for 2.4 GHz and 5 GHz.

- High data rates (up to 450 Mbit/s in conjunction with channel bonding) with 3x3 MIMO technology (Multiple Input, Multiple Output); here, SCALANCE W client modules use three streams each for simultaneous transmission and reception
- Suitable for any application:
 - For installation in the control cabinet
 - For installation without a control cabinet
- Reliable thanks to rugged enclosure, protected from water and dust (IP65), resistant to shock, vibration and electro-magnetic fields
- Complex applications with redundancy requirements and high bandwidths, e.g. for video, by using IEEE 802.11n
- Configuration support by means of wizards and online help; easy management via Web server and SNMP
- Fast replacement of devices in event of failure by means of optional C-PLUG (Configuration Plug) swap medium

	Industrial Wireless LAN according to IEEE 802.11		Industrial Wireless LAN incl. iFeatures	
	Access Points	Client Modules	Access Points	Client Modules
For outside environments	W786 RJ45 / W786 SFP 		W786-2RR 	
For interior environments	802.11a/g/n W788 M12 	W748 M12 	W788-1RR / W788-2RR 	W747-1RR 
For cabinets	802.11a/b/g W788 RJ45 	W748 RJ45 	802.11a/b/g W784-1RR 	W747-1 
	W784-1 	W744-1 / W746-1 		IWLAN / PB Link PN IO 
Mobile operating		Field PG 		Mobile Panel 277F (IWLAN) 
Wireless Devices				ET200pro IWLAN 

SCALANCE W access points and client modules

Industry-standard products for wireless communication

Antennas and accessories

Antennas

Remote antennas increase the reliability of wireless links by optimizing the receiving and emission of signals.

- Unidirectional and omnidirectional antennas for different radio field architectures
- Use in Industrial Wireless LAN (IWLAN) and WLAN in accordance with IEEE 802.11 at 2.4 GHz and 5 GHz with transmission rates of up to 450 Mbit/s
- Coordinated range of antennas for different applications both indoors and outdoors
- Antennas with two (dual-slant) or three (MIMO) connections for enhanced data throughput and increased reliability of the wireless connection thanks to selective use of multiple path propagation
- Suitable for use in hazardous areas (Zone 2); no special approvals necessary









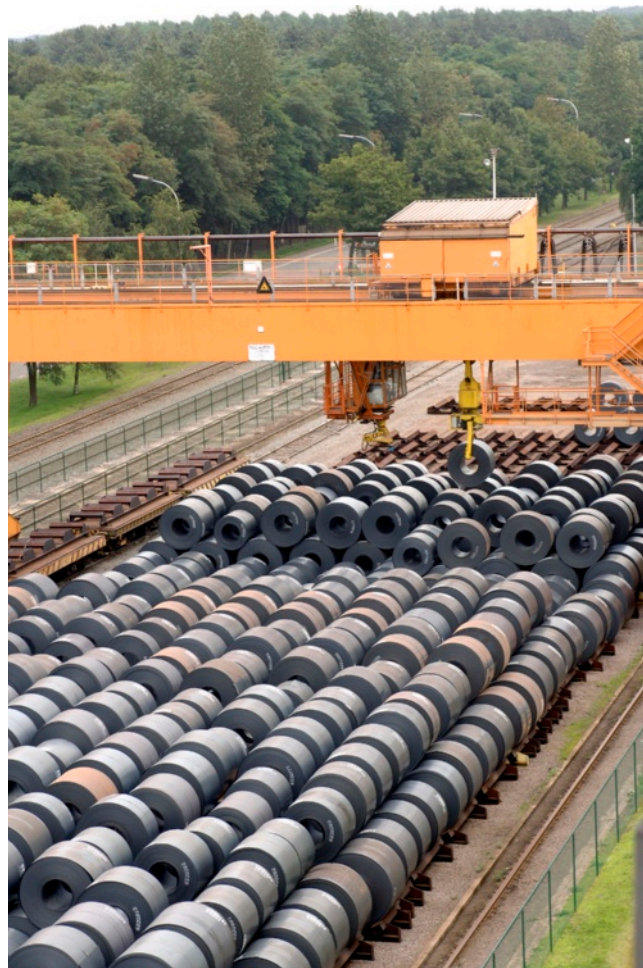













Antennas with multiple connections (dual or MIMO antennas)

Antennas with two connections combine two individual antennas, at 90° to each other, in a single antenna enclosure. With these antennas, two data streams can be transferred simultaneously thanks to the two different polarization levels. Depending on the alignment of the polarization levels, these antennas are referred to as dual-slant (rotated through $\pm 45^\circ$) or vertical-horizontal.

Antennas with three connections contain three individual emitters that can be combined in a single enclosure, either on different polarization levels (0° , $\pm 45^\circ$) or at a suitable distance from each other. The so-called MIMO antennas can transmit three data streams simultaneously using multiple path propagation. Transmission of several data streams results in increased data throughput with simultaneously achieving more reliable data transfer.



Antennas exclusively for SCALANCE W-700 according to IEEE 802.11n						Antennas for SCALANCE W-700 according to IEEE 802.11n and 802.11a/b/g		Antennas exclusively for SCALANCE W-700 according to IEEE 802.11a/b/g	
with 1 connection		with 2 connections (dual)		with 3 connections (MIMO)		with 1 connection		with 1 connection	
	ANT795-4MA		ANT793-6DG		ANT795-6MT		ANT792-4DN		ANT795-4MR
	ANT795-4MC		ANT793-8DJ		ANT793-6DT		ANT793-4MN		ANT795-4MS
	ANT795-4MD		ANT793-8DK				ANT792-6MN		ANT795-6DN
	ANT795-6DC						ANT793-6MN		ANT793-8DN
							ANT792-8DN		
							ANT795-6MN		
							RCoax radiating cables		

G_JK10_XX_30286

Overview of WLAN antennas

Industry-standard products for wireless communication

IWLAN RCoax Cable

When operated as an antenna for SCALANCE W access points, IWLAN RCoax radiating cables offer a reliable radio connection in areas where standard antenna technology can only be installed at great cost.

The defined conical radio field running along the radiating cable enables the secure transfer of data to all plants in which mobile stations move along defined lines.

The RCoax cables were specially designed for the frequency bands around 2.4 GHz and 5 GHz.

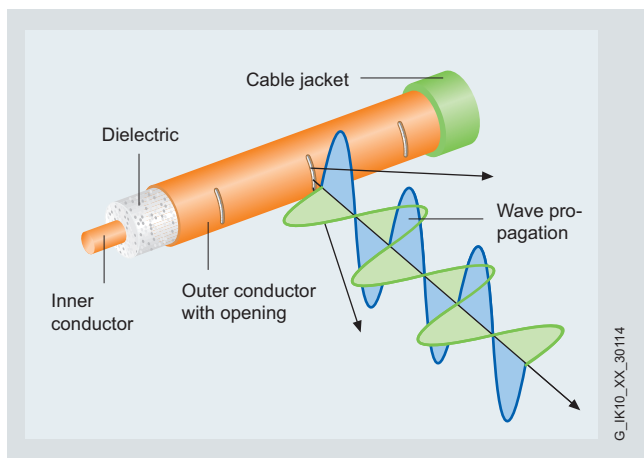

Structure of RCoax cable

Openings are present in the outer conductor of the coaxial cable which permit the penetration and emission of radio waves. This permits development of a defined radio field around the RCoax cables. Longitudinal damping and extraction loss are in a balanced relationship, which permits a long segment length of cable per SCALANCE W780 Access Point and an appropriate distance from the mobile station (SCALANCE W740, IWLAN/PB Link PN IO) to the RCoax cable.

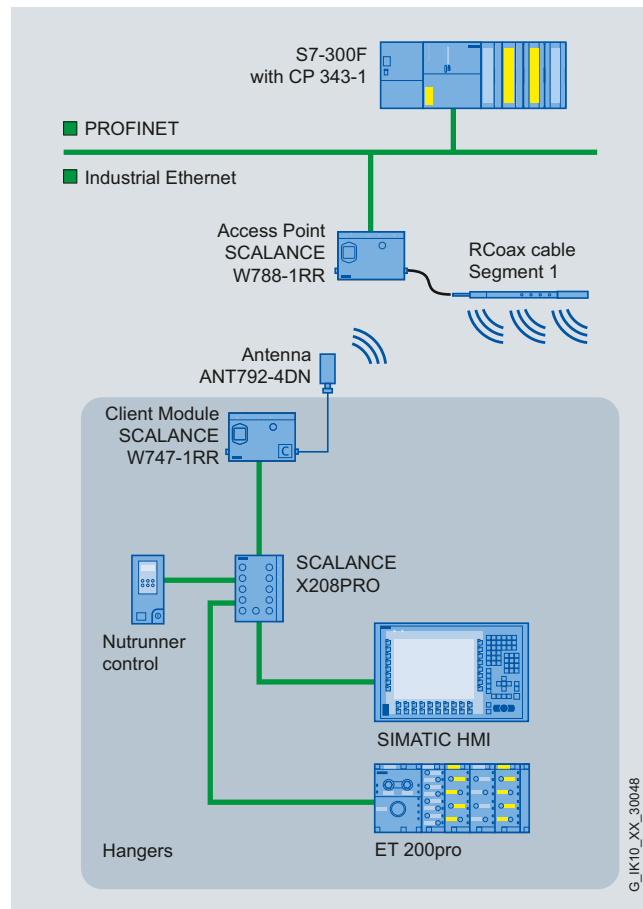



- Reliable inspection in demanding areas such as cranes, high-bay storage and retrieval units, transfer lines, tunnel or monorail conveyors
- Controlled radiated emission of radio waves
- Minimal interference/reciprocal interference owing to the low-level transmit power
- Savings in costs through direct substitution of contact conductors and trailing cables
- High flexibility in use

Industry-standard products for wireless communication

Field PG and Mobile Panel 277(F) IWLAN

Field PG M3 – the mobile programming device in notebook form

The mobile and industrialized SIMATIC Field PG in notebook form is ideal for mobile use on site, even in areas with restricted space or when traveling.

Its main applications include:

- Start-up
- Service
- Maintenance
- Configuration
- Programming

of automation systems.

Despite its compact design, the Field PG's 14.1" TFT display with 1024 x 768 pixel resolution offers a convenient and ergonomic working environment.

A powerful lithium ion battery (66 Wh) enables several hours of off-mains operation and maximum mobility.

In addition, an interface box that operates as a fan-out unit can be connected to the Field PG with Pentium 4.

A PCMCIA radio interface permits connection to wireless local networks.

SIMATIC Mobile Panel 277(F) IWLAN

- The Mobile Panel 277(F) IWLAN is the first wireless, flexibly configurable mobile operator terminal with "Safety Integrated" technology
- Flexibly configurable HMI with Industrial WLAN IEEE 802.11 a (b/g)
- Support for SCALANCE W access points (recommended for Safety mode) with iFeatures for:
 - Traffic with critical real-time requirements
 - Dedicated bandwidth
 - Authentication/encryption

- TÜV/BIA certification to SIL3
- "Safety Integrated" technology is available as an option
- Transponder identification and distance measurement for secure logon and operation
- Supports PROFINET and PROFI-safe
- Project download possible via WLAN/USB/Ethernet
- Can be configured with WinCC flexible
- "Powersave" mode for optimizing the operating time
- Battery change 'on the fly'
- Wall-mounted cradle for charging the main battery, the parallel charging of spare batteries and safe storage of the device



ET200pro IWLAN

Interface module for handling communication between ET 200pro and host PROFINET IO controllers over Industrial Wireless LAN (IWLAN) radio networks for 2.4 GHz or 5 GHz with data transfer rates up to 54 Mbit/s.

- IP65/67 degree of protection for cabinet-free use at the machine
- Small, multi-functional complete solution
- Modular design in the I/O system
- Effective encryption mechanisms protect against unauthorized access, spying, tapping, and corruption
- Fast exchange of devices through use of MICRO MEMORY CARD swap medium
- Comprehensive diagnostics: module or channel specific



Industry-standard products for wireless communication

IWLAN/PB Link PN IO

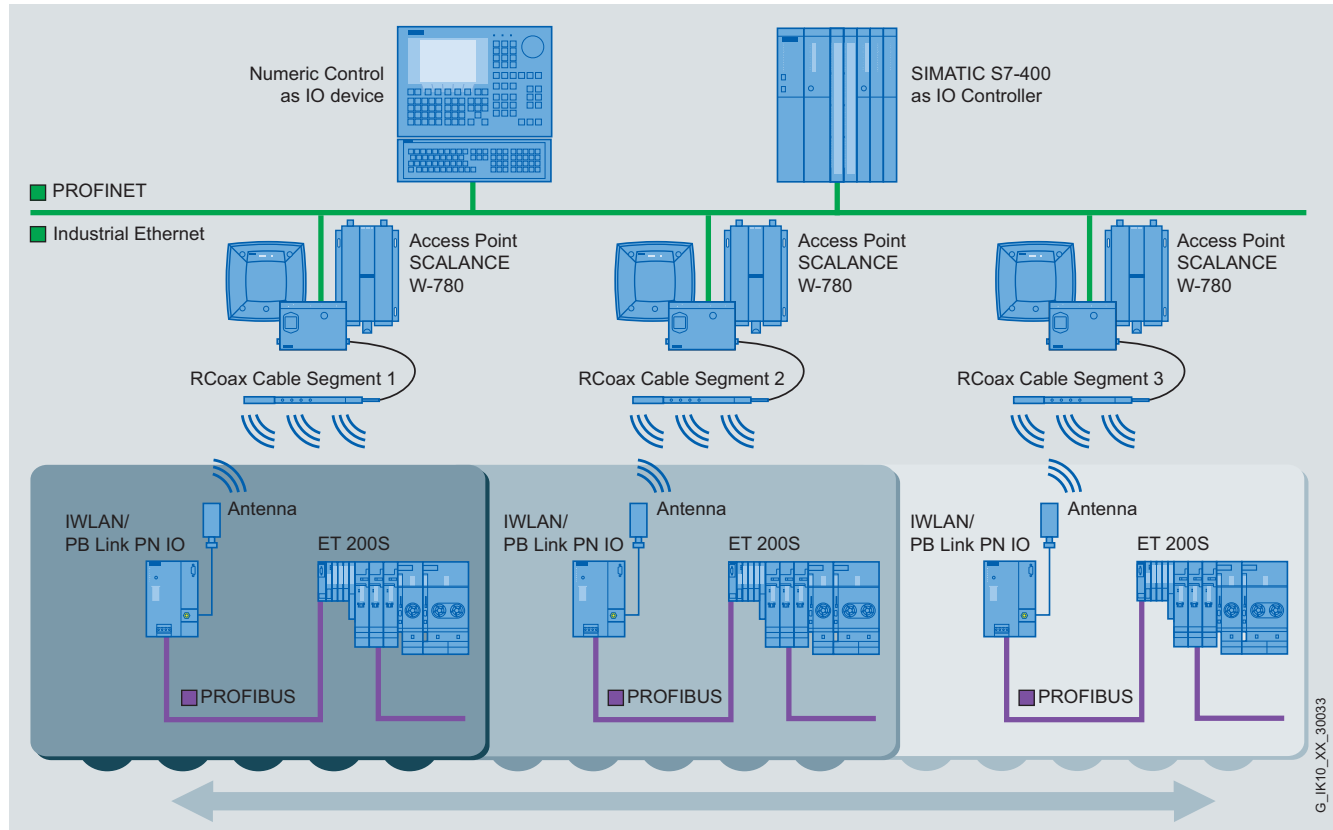

System solution with IWLAN/PB Link PN IO using example of suspended monorails

The IWLAN/PB Link PN IO is a compact router between Industrial Wireless LAN (IWLAN) and PROFIBUS, and allows wireless connection to an IWLAN (e.g. SCALANCE W access points) in accordance with IEEE 802.11 at up to 54 Mbit/s with 2.4 GHz and 5 GHz.

It supports the use of an IWLAN, for example with RCoax radiating cables, for wireless data transmission in the case of suspended monorails, storage and retrieval systems, or other applications with mobile stations. Support of PROFINET means that the wide variety of PROFIBUS system services, such as diagnostics over the bus, can still be utilized.

The IWLAN/PB Link PN IO offers:

- High, deterministic data throughput and very fast roaming through support of iPCF; the iPCF mechanism represents an extension of the IEEE 802.11 standard and must be available both on the station and on the access point.
- PROFINET IO proxy functionality
Connection of PROFIBUS DP slaves to PROFINET IO controller according to PROFINET standard:

- From the viewpoint of the IO controller, all DP slaves are handled like IO devices with Ethernet interface, i.e. the IWLAN/PB Link PN IO is their proxy
- From the viewpoint of the DP slaves, the IWLAN/PB Link PN IO is the DP master



Industrial Wireless LAN

Advantages at a glance

- Reliable radio link, e.g. by using MIMO technology, redundant connections, and monitoring of the radio link
- Predictable data traffic (deterministic) and defined response times on the radio link with the assistance of iFeatures
- Cost savings due to one single radio network both for process-critical data and for non-critical communication
- Investment security because all products are compatible with the internationally recognized WLAN standard IEEE 802.11, suitable for license-free 2.4 GHz and 5 GHz frequency bands (ISM bands)

- Operational reliability in industrial environments, e.g. thanks to rugged housing and industrial approvals
- Reduced operating costs, because there is no wear of rotating and moving plant sections
- Cost-effective connection to devices which are remote, difficult to access or mounted in hostile environments
- Increased reliability when operating the IWLAN through complete, coordinated portfolio of controllers, industrial access points and SCALANCE W client modules, as well as the suitable accessories (antennas, connecting cables, power supplies)

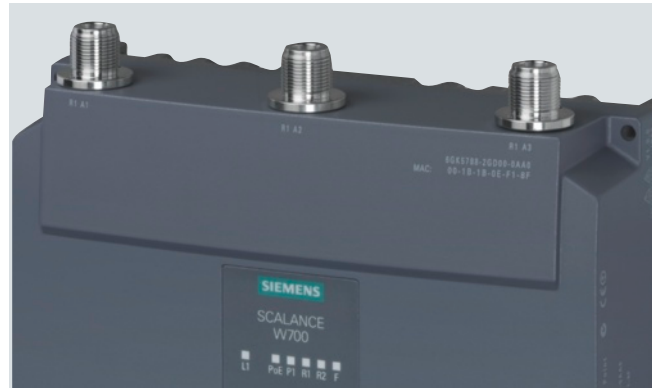

Get more information

SIMATIC NET:

www.siemens.com/automation/simatic-net

Industrial Wireless Communication:

www.siemens.com/industrial-wireless

Info material for downloading:

www.siemens.com/automation/infocenter

Service & Support:

www.siemens.com/automation/service&support

SIMATIC NET contacts:

www.siemens.com/automation/partner

Industry Mall for electronic ordering:

www.siemens.com/industrymall

Siemens AG
Industry Sector
Sensors and Communication
Postfach 4848
90026 NÜRNBERG
GERMANY

Subject to change without prior notice
Order No.: 6ZB5530-1AM02-0BA6
MP.R1.SC.ICBR.48.2.12 / Dispo 26000
BR 0412 2. ROT 28 En
Printed in Germany
© Siemens AG 2012

www.siemens.com/automation

The information provided in this brochure contains descriptions or characteristics of performance which in case of actual use do not always apply as described or which may change as a result of further development of the products. An obligation to provide the respective characteristics shall only exist if expressly agreed in the terms of contract. Availability and technical specifications are subject to change without notice.

All product designations may be trademarks or product names of Siemens AG or supplier companies whose use by third parties for their own purposes could violate the rights of the owners.