

Throttling Characteristics of Multi-Hole Orifice in Multi Stage Assembly

K. Mohamed Kaleemulla¹, K.G. Satish¹, K. Sandeep² and K.J. MahendraBabu³

¹Department of Mechanical Engineering, University BDT College of Engineering, Davanagere -577004, Karnataka, India. E-mail: kmk.bdt@gmail.com.

²Department of Mechanical Engineering, BTL Institute of Technology, Bangaluru-577099, Karnataka, India.

³Department of Mechanical Engineering, PES College of Engineering, Mandya-571401, Karnataka, India.

Abstract— Flow measurement is a primary requirement of most piping systems. Though it is a simple task to determine the quantity of flow; frequently it poses significant challenges. Multi-hole orifice plate is mostly used as throttle element. Compared to single-hole orifices multi-hole orifices have smaller orifice sizes and various patterns of orifice distribution. For a single-hole orifice plate there is no neighbor turbulence that choke the pressure recovery, in case of multiple-hole orifice plate the expansions of one jet will impact with the expansions of the others limiting the pressure recovery. A series of throttle tests in water flow is conducted to investigate the effect of various geometric features like the total orifice number, orifice with different configurations, aspect ratio, Diameter ratio, and throttling effect in multi stage assembly on the pressure loss characteristics of multi hole orifice. From this study it is found that the scattering of the discharge coefficient would become serious, when the hole numbers are small enough, while discharge coefficient will increase and corresponding decrease of differential pressure when the numbers of holes are large enough. Both the number of holes and their distribution have significant impact on the pressure drop and further on the discharge coefficient.

Keywords: Multi-hole Orifice; Discharge Coefficient; Differential Pressure; Reynolds Number.

I. INTRODUCTION

There are so many flow meters to choose from that it can be confusing deciding on the one most appropriate for a given application. A number of primary elements belong to this class namely concentric orifice, wedge flow meter, venture nozzle, venture meter, V-cone meter etc. Orifice plates are mainly used as a device of flow measurement, control of fluid flow for fluid delivery systems is based on the measurement of the pressure difference created when forcing the fluid to flow through a restriction in the pipe. Knowledge of pressure drop for single phase flows through valves, orifices and other pipe fittings are important for the control and operation of industrial devices such as chemical reactors, power generation units, refrigeration apparatuses, oil wells, and pipelines. The orifice is one of the most commonly used elements in flow rate measurement and regulation. Because of its simple structure and reliable performance, the orifice is increasingly adopted in gas-liquid two-phase flow measurements. Single orifices or arrays of them constituting perforated plates, are often used to enhance flow uniformity and mass distribution downstream of manifolds and distributors.

Multi-hole orifice plate (MO) is mostly used as throttle element. Compared to single-hole orifices multi-hole orifices have smaller orifice sizes and various patterns of orifice distribution. The multi-hole orifice plates assumed to be composed of number of individual orifices acting parallel and independently will have flow characteristics different compared to the flow characteristics of a single hole orifice plate having same flow area. This is basically because of the flow restriction due to small flow area of each hole. Flow measurement is one of the most complex and demanding tasks in industry. With particular reference to orifice geometry Guohui Gan et al. [2] for a square-edged orifice plate and a multi-holed perforated plate showed that the orifice plate had a lower pressure drop than the perforated plate, which constructed earlier findings of Idelchik et al. [8] and determined their pressure loss coefficients. The acoustic effects of cavitation were discussed by testing a circular centered single-hole orifice and a multi-hole orifice by P. Testud et al. [6]. Dug dale [3] mathematically modeled the radial and angular velocity profiles of a sharp-edged orifice. The shape, size, and angel of perforation have no considerable effect on discharge factor of perforations further the pressure difference across the standard and multiple-hole orifice plate mounted coaxially in straight cylindrical pipe was measured experimentally by Tianyi Zhao et al. [1]. Shanfang Hung, et al. [7] concluded that the pressure drop due to minor friction determines the performance of differential pressure orifices.

The work presents the numerical investigation of the pressure difference across the standard and multiple-hole orifice plate mounted coaxially in straight cylindrical pipe and the results are compared against the results of the author [1] to explain the reliability of analysis. The same geometric architecture was employed to explain the reliability of numerical technique. And the study is extended for different diameter ratio (DR), orifice number (n), thickness (t) and multiple-hole distribution; along with corresponding discharge coefficients were presented.

Orifice Arrangement Criteria: The random number and arrangement of orifices leads to the complexity of MO geometry hence to avoid complexity, the criteria as in reference [1] were adopted they are;

1. Each orifice center can be located in a set of concentric circles defined as center circles, as in Fig. 1 (a) & (b).
2. Orifice arrangement should be symmetrical, and the spacing among most orifice centers should be equal.
3. MOs can be arranged with or without a centered orifice, as shown for typical 9-hole MOs in Fig. 1 (a) and (b), respectively.
4. All holes in each multiple-hole orifice have a uniform size, with orifice plate thickness of 2 mm. For simplicity the total orifice number, $n=4$ and 9 and the maximum number of center circles was two.

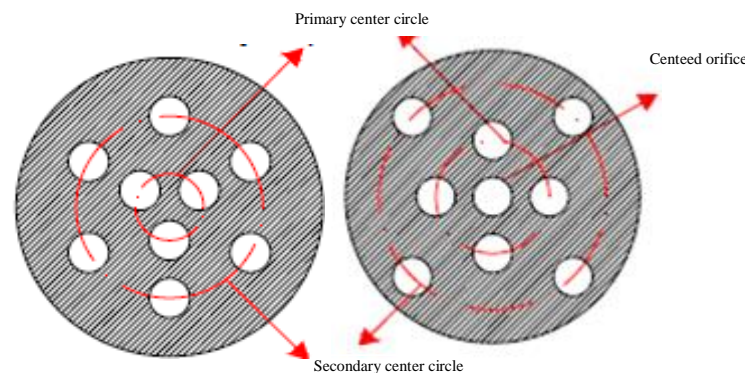

Fig. 1 MO geometric architecture, (a) without a centered orifice (b) with a centered orifice.

Key Geometric Parameters: According to the above definitions, the following three geometric parameters were used to quantitatively characterize the MO geometry. These geometric parameters can be used to explicitly describe the MO geometry.

1. The total orifice number, n .
2. The equivalent diameter ratio, EDR, which represents the square root of the total open area ratio and is expressed as $n^{0.5} d/D$. EDR for multi-hole orifice has the same geometric meaning as the diameter ratio defined for SO specified in ISO5167.
3. The orifice distribution density D_d , which is expressed as d_{hmin}/D , where d_{hmin} represents the minimum spacing between the edges of the orifices located at adjacent center circles.

II. METHODOLOGY

Computational Fluid Dynamics (CFD) is an area in which the governing equations for fluid flows are solved in discrete form on computers by simulating the fluid flow problem. CFD is used for governing partial differential equations of fluid flow with manageable algebraic equations and to obtain final numerical description of the complex flow field of interest. Numerical solution procedure requires the repetitive manipulation of numbers. Therefore, advances in numerical procedures and its application to problem of more and more details and sophistication are intimately related to advances in computer hardware, particularly with regard to storage and execution speed. The numerical simulation of the flow region of interest requires: (1) Modeling and Meshing, (2) Choice of numerical method, (3) Execution for obtaining results, and (4) Interpretation of the results.

The main aim of this work is to analyze and document the throttling characteristic of Multi-hole orifice in Multi-Stage assembly using Computational Fluid Dynamics (CFD). The study will be carried out using commercial CFD code FLUENT, it is one of the many commercial packages available to perform CFD. It is also the most widely used general-purpose CFD software to perform fluid flow and heat transfer analysis of real industrial processes. Its unique capabilities include an unstructured, finite volume based solver which is near-ideal for parallel performance. GAMBIT is used as the pre-processor to create computational domain.

Physical Data of Orifice Plate

TABLE 1: PHYSICAL DATA FOR SINGLE AND MULTIPLE-HOLE ORIFICE PLATE

Number of holes	Diameter Of each hole (mm)	Aspect ratio (t/d)	Diameter Ratio (DR or EDR)	Types of hole arrangement	Thickness (mm)
One	12.5	0.16	0.25	Concentric	2
	20	0.1	0.4		1.5 and 2
	30	0.07	0.6		
Four	6.25	0.32	0.25	Type-2	2
	10	0.2	0.4		
	15	0.13	0.6		
Six	5.1	0.39	0.25	Type-1	2
Nine	4.16	0.48	0.25	Type-2	2
	6.67	0.3	0.4	Type-2 and Type-3	
	10	0.2	0.6	Type-2	1.5 and 2

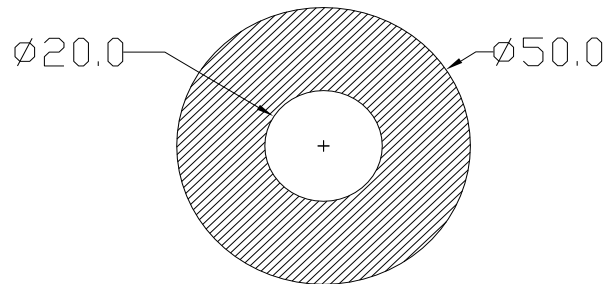

Fig. 2 Orifice is concentric to cylindrical pipe in case of S-0.4 (Concentric).

Pipe diameter is of 50 mm, being constant in all cases. For single-hole orifice, the hole is located as concentric to the pipe (Fig. 2). In all case of multiple-hole one hole is located concentric to orifice similar to single orifice and remaining holes centers are distributed in concentric center circles. Concentric center circle contains centers of multiple-holes arranged symmetrically over the cross section of plate. Type-1 contains two concentric circles as shown in Fig. 6. Type-2 contains only one concentric circle (Fig. 3 and 4), which is of most cases, used for the analysis. Type-3 is modeled for change in distribution with two concentric circles as shown in Fig. 5. Here 4M-0.4 and 9M-0.4 represent the 4 and 9 multiple-holes orifice respectively, with a diameter ratio of 0.4 each.

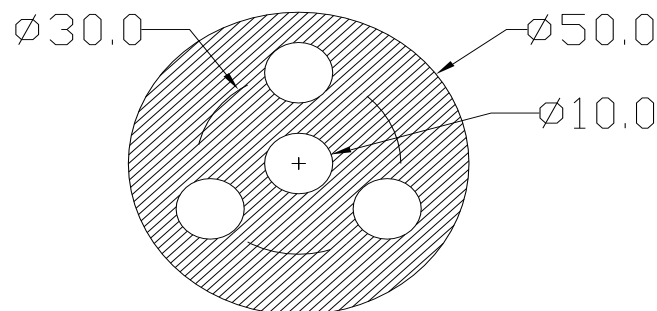

Fig. 3 Type-2 distribution of holes in case of 4M-0.4.

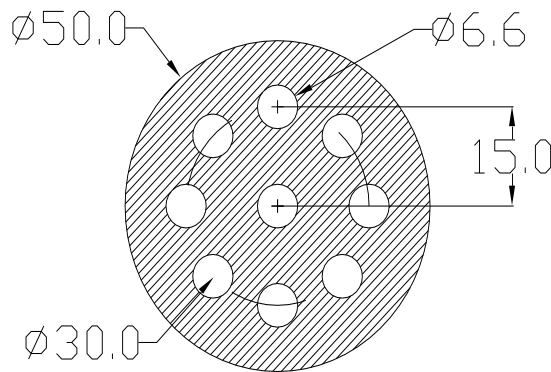

Fig. 4 Type-2 distribution of holes in case of 9M-0.4.

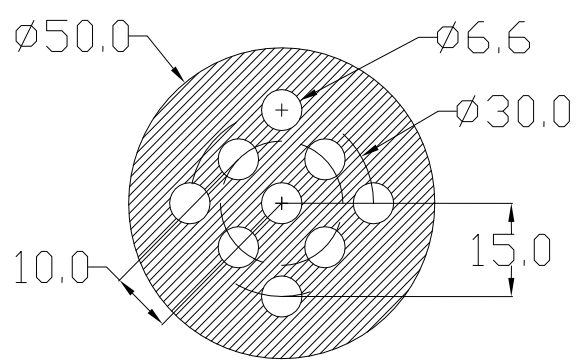

Fig. 5 Type-3 distribution of holes in case of 9M-0.4.

III. THEORETICAL ANALYSIS

The pressure difference across orifice is given,

$$\Delta P = 0.5\rho^{-1} \left(\frac{\mu}{D}\right)^2 \left(\frac{Re_D}{C}\right)^2 (DR^{-4} - 1) \quad (1)$$

The SO discharge coefficient C_d can be calculated using the Stolz equation (Eq.) [10].

$$C_d = 0.5959 + 0.0312DR^{2.1} - 0.0184DR^8 + 0.0029DR^{2.5}(106/Re_D)^{0.75} + 0.039L_1DR^4(1 - DR^4) - 1 - 0.0337L_2DR^3 \quad (2)$$

The Reader-Harris/Gallagher equation to determine the discharge coefficients according to ISO5167 (2003) is given [10],

$$C_d = 0.5961 + 0.0261DR^2 - 0.216DR^8 + 0.000521 \left(\frac{10^6 DR}{Re_D}\right)^{0.7} + (0.0188 + 0.0063A)DR^{3.5} \left(\frac{10^6}{Re_D}\right)^{0.3} + \frac{(0.043 + 0.08e^{-10L_1} - 0.123e^{-7L_1})(1 - 0.11A)DR^4}{(1 - DR^4)} - 0.031(M - M^{1.1})DR^{1.3} + 0.011(0.75 - DR) \left(2.8 - \frac{D}{25.4}\right) \quad (3)$$

Where,

$L_1=1, L_2=0.47$ for the D and $D/2$

pressure tapping measurements, $A = (19000DR/Re_D)^{0.8}$ and $M = -2L_2/(1 - DR)$.

Sufficient upstream and downstream lengths of the pipeline were provided in the simulation. The longer downstream length was chosen in order to ensure that the boundary conditions at the exit of the pipe have no significant effect on the computed flow field. Fig. 6 shows a schematic of orifice. For the perforated orifice a number of holes with same diameter are symmetrically distributed over a cross section of the plate. To better understand the performance of perforated orifice, a comparison made with corresponding standard orifice that has a single round hole at the center. For a differential standard device both perforated and standard, the working principle is based on the firm relationship between the pressure drop and volumetric flow rate:

$$qv = \frac{C_d \varepsilon A_o}{\sqrt{1 - DR^4}} \sqrt{2\Delta p / \rho} \quad (4)$$

Where, q_v , ρ , C_d , DR and Δp are the volumetric flow rate, the fluid density, the discharge coefficient, the diameter ratio, and the pressure drop across the orifice; ε is an expansibility factor being unity for an incompressible fluid. The diameter ratio, DR , as an important parameter to characterize the structure, is determined by the ratio of the orifice area, A_o , to the pipe area, A_1 :

$$DR = \sqrt{\frac{A_o}{A_1}} \quad (5)$$

From equation (4), the discharge coefficient C_d is given,

$$C_d = \frac{q_v \sqrt{1 - \beta^4}}{A_o \epsilon \sqrt{\frac{2\Delta P}{\rho}}} \quad (6)$$

In engineering application, C_d should be a constant so that pressure drop is unique variable in determining q_v . When the flow rate is below a critical Reynolds number, the flow is unstable, indicating that C_d is no longer a constant and that the flow meter is disabled. Because the distribution of the holes over the cross section of the plate has an important effect on pressure drop and further on the discharge coefficient, it needs more detailed discussion. However it is not a problem for a standard orifice with only one round hole. Pressure drop across an orifice is due to gravity, acceleration, shape drag and friction, respectively. Acceleration and gravitational pressure is negligible in a horizontal straight pipe flow. Therefore ΔP can be simplified as:

$$\Delta P = \Delta P_1 + \Delta P_2 \quad (7)$$

Where, ΔP_1 , and ΔP_2 are the friction pressure drop along the pipeline, and the minor friction pressure drop due to the interference to the flow field by the orifice, respectively. From equation (6), we get

$$C_d \propto \frac{q_v}{\sqrt{\Delta P}} = \frac{q_v}{\Delta P_1 + \Delta P_2} \quad (8)$$

The major friction pressure drop can be expressed as,

$$\Delta P_1 = f \frac{L}{D} \frac{\rho v^2}{2} \quad (9)$$

Where, f is the friction coefficient being constant in a fully developed flow, as can be seen in Moody Map[12]; L/D is the relative length of the system; and v is the averaged velocity over the cross section of the pipe. A K Jain derived the following approximation,

$$f = \left[1.14 - 2 \log_{10} \left(\frac{C}{D} + \frac{21.25}{Re^{0.9}} \right) \right]^{-2} \quad (10)$$

Even though structure of the orifice plate is simple, the flow behavior is complex across the plate. In this case, an averaged velocity will increase due to an abrupt change in channel, results in decrease of static pressure related to minor friction loss. For a standard orifice with one round hole, the minor friction coefficient, K , can be expressed as [8],

$$K = 0.5 \left(1 - \frac{A_o}{A_1} \right)^{0.75} + \tau \left(1 - \frac{A_o}{A_1} \right)^{1.375} + \left(1 - \frac{A_o}{A_1} \right)^2 + \frac{ft}{D} \quad (11)$$

Where A_o and A_1 are the areas of orifice and the pipe, respectively; τ is the constant related to thickness of the plat, t :

$$\tau = (2.4 - t) * 10^{\left(0.25 + \frac{0.531t^8}{0.05+t^8} \right)} \quad (12)$$

From equation (11), K increases with a decrease in hole-area, corresponding to a higher traversing velocity over the cross section of the pipe. The thickness of the orifice plate is so small as not to have an evident effect on the minor friction coefficient in the engineering range. For a multiple-hole orifice, the holes can be regarded as parallel connected, where equation (11) still valid through each hole. The minor friction loss coefficient, K , is lower than that of the corresponding standard orifice since the hole-area is smaller for the multiple-hole orifice. Furthermore we can strengthen the concept by comparing the velocity distribution in the two cases. Although it is convenient to describe qualitatively the expression of discharge coefficient and tell the difference between the two orifices, it is impossible to obtain theoretically the exact expression of discharge coefficient. Besides a complex flow field, the orifice structures also have effects on the orifice performance. Additionally, numerical investigations are very scarce for multiple-hole orifices compared with standard ones. Therefore it is necessary to carry out systematic numerical investigation to quantitatively obtain the differential pressure and coefficient of discharge for the multiple-hole orifice.

IV. GEOMETRIC MODELLING AND CFD ANALYSIS

Modeling: The geometry of the flow domain was modeled using a bottom-up approach in Geometry and Mesh Building Intelligent Toolkit (GAMBIT). 3D model has been used for concentric single hole and multiple holes orifice plate. The process of grid generation is very crucial for accuracy, stability and economy of the prediction. A fine grid leads to better accuracy and hence it is necessary to generate a reasonably fine grid in the region of steep velocity gradients. On the other hand, regions where smooth flow exists could be meshed with coarse grids. For flow simulations, the flow domain has been meshed with structured grids of hexahedral cells. Number of hexahedral cells generated while meshing the domain lies between 10 lacks and 20 lacks with quality value ≤ 0.6 . Hexahedral cells are less dissipative than tetrahedral

cells. For efficient meshing, the geometry was divided into three parts, upstream, central region and downstream of the orifice. The upstream and downstream regions were meshed with reasonably coarse grid whereas the central region containing the obstruction and pressure taps was meshed with very fine grid in order to study the effect of obstruction geometry. The sizes of grid were kept very fine in the central region to account for the expected steep velocity gradients there. The upstream and downstream straight pipe lengths have been included in the flow domain so that the computational accuracy is not affected by the imposition of the boundary conditions. The boundary at the Inlet and outlet of the pipe are defined as VELOCITY INLET and PRESSURE OUTLET. However, all solid surfaces are treated as WALL.

Solution Scheme and Boundary Conditions: Flow investigations were carried out using CFD Code “FLUENT” which is based on a cell centered finite volume approach. A second order discretization scheme was used for all governing equations. Under-relaxation factors were used for all parameters to satisfy the Scarborough condition for convergence of the solution. Coupling between the pressure and velocity field was established using the SIMPLE Patankar scheme, [18]. Discretized equations were solved by a segregated solver and an implicit solution scheme. Solutions were converged until the sum of all the residual terms were less than 10^{-3} . Viscous model selected for steady state analysis is standard k- ϵ model. Inlet velocity is varied from 0.0002 to 1.5 m/s by keeping inlet boundary condition as velocity inlet and outlet boundary condition as pressure outlet, which could be subjected to change in Fluent while specifying them, which are already defined in GAMBIT. The outlet boundary condition is specified with atmospheric pressure. The walls are subjected to no-slip boundary condition

V. RESULTS AND DISCUSSION

As a flow-meter a differential pressure orifice is required to have a constant discharge coefficient in fully developed flows and to be independent of Reynolds number [11]. In order to study the performance of perforated orifice, focus should be made on their structural parameters such as diameter ratio, orifice thickness, number of holes and their distributions. In this section, typical numerical analysis data of differential pressure and discharge coefficients are presented, and comparisons are made between the multiple-hole and corresponding standard orifices along with its Stoltz experimental correlation. Based on these results, effects of different structural parameters on differential pressure and discharge coefficients can be predicted in single stage as well as in multi stages of multiple-hole and corresponding standard orifice assembly.

Fig.10 presents profiles of differential pressure and Fig. 11 to 13 shows discharge coefficient for multiple-hole and corresponding standard orifices as a function of Reynolds numbers, where thickness was kept as constant of 2 mm. The profiles of C_d and ΔP for the multiple-hole orifices are found to be similar in shape with different numbers of orifice. For each profiles of discharge coefficient it can be divided into two parts, a transition and a steady region, by a critical Reynolds number, $Re_{critical}$. By a similar method, the discharge coefficient can be obtained for a standard orifice of diameter ratio 0.6, Fig. 13, which shows good agreement with the Stolz equation. Comparisons in discharge coefficient and pressure drop profiles between a multiple hole and a corresponding standard orifice helps to understand the performance of the former. For multiple-hole orifices, the discharge coefficient increases first and then decreases before tending to a constant, where as it decreases monotonically for the corresponding standard orifice. As to $Re_{critical}$, it is lower for a multiple orifice than for the corresponding standard one, implying that the former orifice has a wider range of application. The variation in discharge coefficient and differential pressure as a function of Re_D across standard and multiple orifices are discussed in following sections.

Validation: Validation of the CFD code establishes the extent of accuracy and reliability of the turbulence model and predictions are accepted only after this step. For validation let us consider two cases of single hole (SO) with DR=0.25 denoted as, S-0.25 and multiple holes (MO's) with EDR=0.25, denoted as M-0.25 as in Fig. 6.

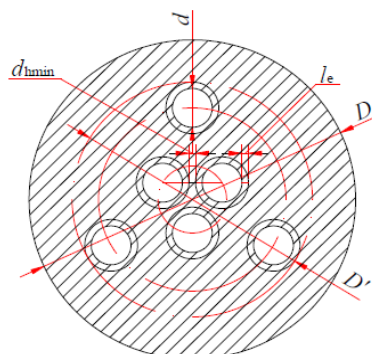

Fig. 6 Schematic configuration of multiple hole-orifices used for validation (Type-1).

As can be observed in Fig. 6,

$$D' < D \tag{14}$$

$$D = 4.155d + 8.311 + 3.154d \tag{15}$$

$$EDR = \sqrt{n} \frac{d}{D} \tag{16}$$

$$D_d = \frac{d_{hmin}}{D} \tag{17}$$

Starting from, Eqs. (14) - (17), the relationship between EDR, D_d and l_e can be determined as [1].

$$EDR < 0.59 - 1.86D_d - 4.9l_e D^{-1} \tag{18}$$

Adopting a D_d value of 0.02, the EDR should be lower than 0.454 because of the test restrictions of $D=50$ mm and $l_e=1$ mm. Because EDR and DR have the same geometric meanings for MO and SO, respectively, the results of this CFD analysis can be compared to available correlations proposed in ISO5167 to investigate the reliability of the analysis data.

Sufficient upstream and downstream lengths of the pipeline were provided in the simulation. The longer downstream length was chosen in order to ensure that the boundary conditions at the exit of the pipe have no significant effect on the computed flow field. Fig. 7 shows variation of ΔP as a function of Re_D and corresponding discharge coefficient is presented in Fig 8. Pressure drop for multiple-hole orifice is more than that of corresponding standard orifice [1, 2]. Thus variation in discharge coefficient found by numerical analysis is 8 to 9% as compared to the results predicted by experimental correlation. There will be an increase in discharge coefficient by 3 to 5% in multiple-hole orifice plate (six holes).

The results of numerical analysis data were compared with the Stolz equation (2) and the Reader-Harris/Gallagher equation (3). It can be observed, that for $S=0.25$, results of the numerical analysis for ΔP were fit well with the results of correlations given by Stolz, especially for a lower Re_D . These profiles show good agreement with review work [1].

The variation in discharge coefficient is 8-10% as compared to results from Stolz Eq. These comparisons may explain the reliability of this numerical analysis, and they indicate that the model is sufficiently accurate for use in a further modeling for change in number of holes, orifice distribution patterns, thickness and diameter ratio. Effect of these parameters on pressure difference across orifice and its coefficient of discharge as a function of Reynolds number were studied extensively.

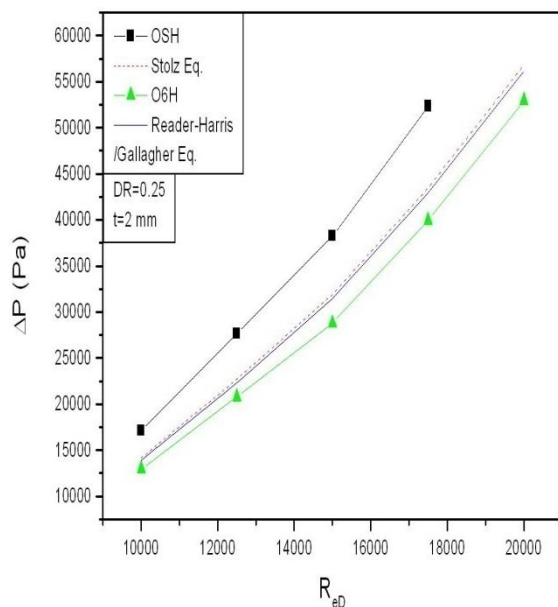

Fig. 7 Differential Pressure across the orifice as a function of Reynolds number.

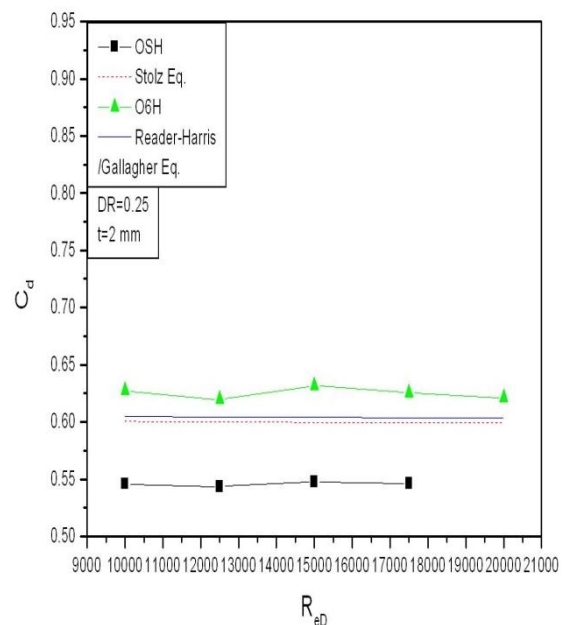

Fig. 8 Discharge coefficient through single and multiple orifice.

Structural effect: Different structural parameters of an orifice determine the discharge coefficient and pressure drop together, and this section presents separately the effects of the structural parameters on discharge coefficient and corresponding pressure drop, including thickness, number of holes, hole diameter and distribution.

Effect of thickness: As observed from Fig. 9, for single hole with different plate thickness of 1.5 and 2mm, numerical investigation predicts almost same results of pressure difference as that found by using Stoltz correlation. This can also be considered for validation of numerical analysis. Pressure difference across Multiple-hole orifice plate is same as that across SO's at lower Reynolds number. Whereas at higher Reynolds number pressure difference decreases as shown in Fig. 9. For multiple holes, increase in thickness result in decrease of differential pressure and corresponding increase in discharge coefficient at higher Re_D .

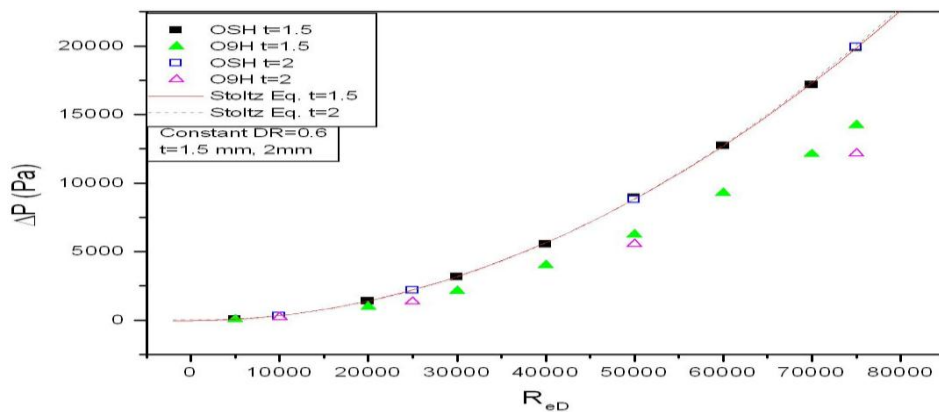

Fig. 9 Pressure difference versus Reynolds number for single hole and nine holes orifice plate with 1.5 and 2mm thickness.

Thus, as thickness increases, the stable discharge coefficient increases with drop in pressure. This can be explicated by the flow distribution across an orifice. When a vortex going through a multiple hole orifice, it would be broken into several small pieces. The swirling in each hole is impaired due to the friction of the orifice wall. When ΔP due to the vortex dissipation is much larger than that due to the friction pressure drop, the total pressure drop is decreasing. The rectifying effect becomes stronger as thickness increases. Therefore, the differential pressure decreases as thickness becomes larger.

Effect of number of holes: To test the effect of number of holes on discharge coefficient three-hole diameters were employed with diameter ratios of 0.25, 0.4 and 0.6. Numbers of holes varied in each case are one, four and nine. By varying the velocity at inlet to flow domain, the C_d and ΔP are calculated at corresponding Re_D . The ΔP is presented in single plot for all cases, whereas the C_d is presented in different plots by keeping DR or n as constant to study effect of individual on C_d .

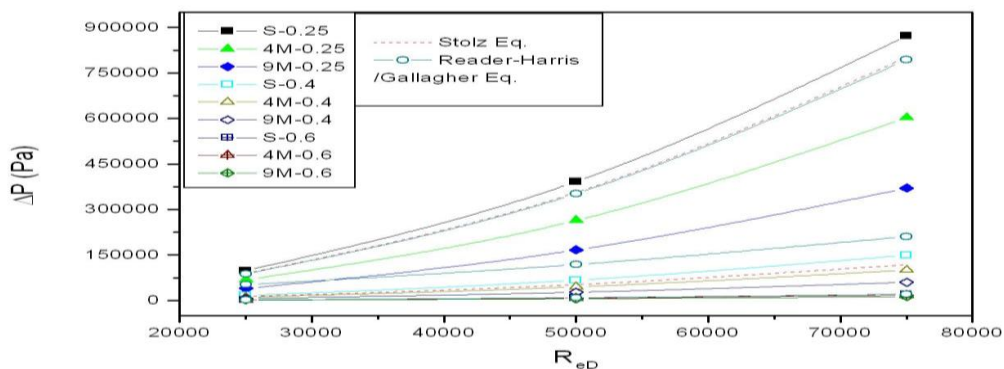

Fig. 10 Effect of variation in number of holes and diameter ratio on differential pressure as a function of Reynolds number.

For $DR=0.25$, the discharge coefficients shown in Fig. 11, the stable discharge coefficient decreases as number of holes decreases. This profile is same for the remaining cases of diameter ratio (DR) 0.4 and 0.6 (Fig. 12 and 13). Meanwhile, Fig. 10 presents the differential pressure as a function of Reynolds number for different physical parameters of both single and multiple-hole orifice plates. The results suggest that the scattering in discharge coefficient becomes

weak as the diameter ratio increases in practical range. Furthermore, it is reasonable to deduce that the discharge coefficient will increase and corresponding decrease of differential pressure when the numbers of holes are large enough. Both the number of holes and their distribution have important impacts on the pressure drop and further on the discharge coefficient. The working mechanism is governed by a universal principle, minimum energy dissipation, which requires that the velocity distribution as well as the equivalent turbulence should be increasing monotonically from the pipe wall to the centerline in a steady flow. This principle is found to be tenable in both single and two phase flows by Joseph and Renardy [13].

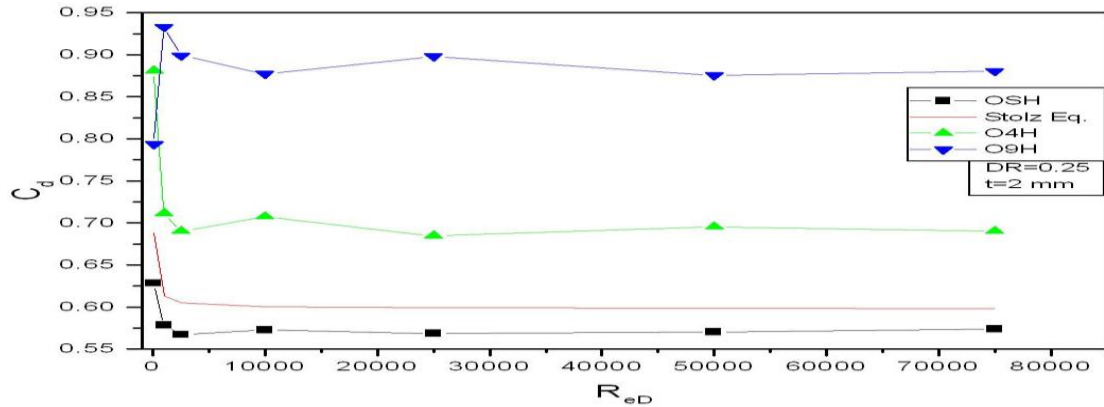

Fig. 11 Effect of variation in number of holes on discharge coefficient with DR=0.25.

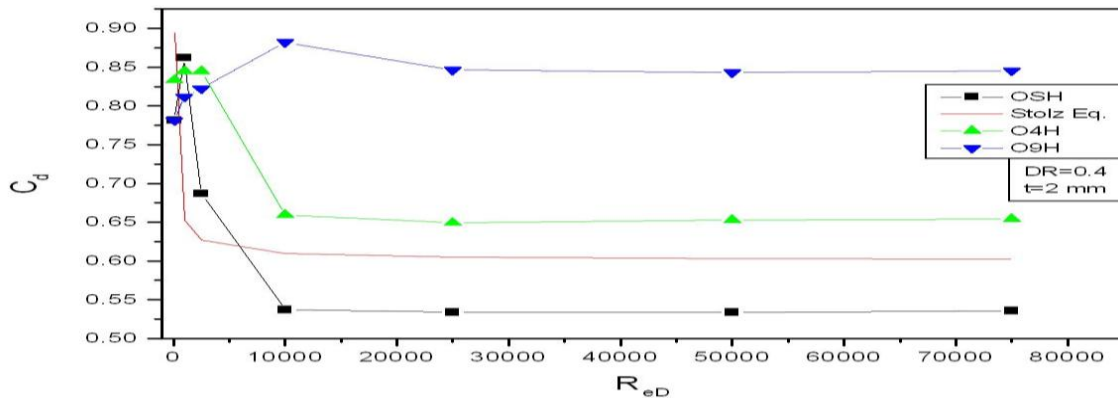

Fig. 12 Effect of variation in number of holes on discharge coefficient with DR=0.4.

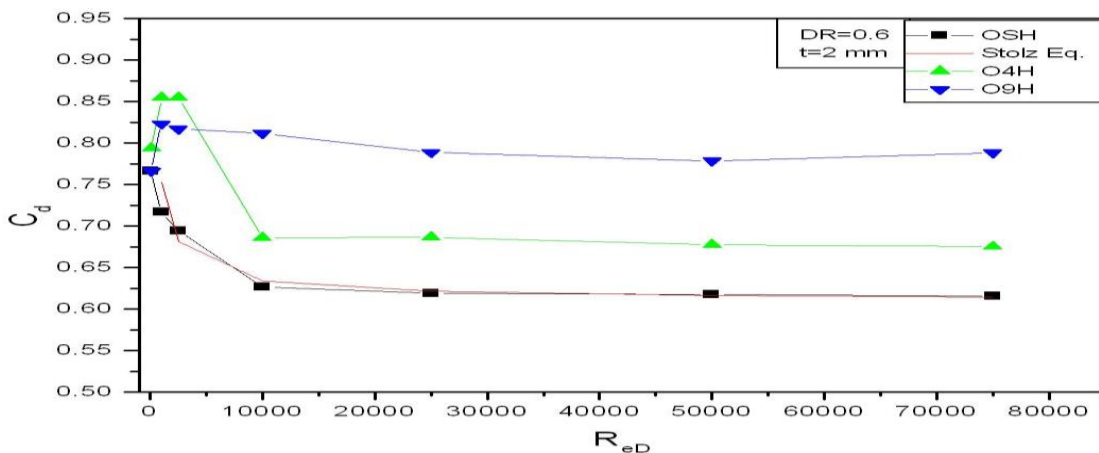

Fig. 13 Effect of variation in number of holes on discharge coefficient with DR=0.6.

Furthermore, it is reasonable to deduce that an extra pressure drop due to the minor friction of a disturbance near the pipe wall is higher than near the centerline. For a series of diameter ratio of 0.25, 0.4 and 0.6, more numbers of holes (9-holes) as compared to less number of holes (4-holes) appears near the pipe wall, where velocity averaged increases

qualitatively even higher than that without the orifice. Pressure drop across the orifice increases with increase in number of holes as shown in Fig. 10 [1,2]. Therefore, for change in number of holes the discharge coefficient increases accordingly as shown in Fig. 11 to 13. As the number of holes increasing, average velocity decreases in each hole for a constant over all flow rates, and this yields an increase in discharge coefficient.

Effect of Diameter Ratio: Diameter ratio effect on discharge coefficient was assessed by varying it as 0.25, 0.4 and 0.6 corresponding to number of holes being one, four and nine for each case of diameter ratio. However number of holes and thickness as 2 mm were kept constant for each orifice. From results shown in Fig. 14 for single orifice coefficient of discharge decreases with increase in diameter ratio from 0.25 to 0.4, then it increases for diameter ratio of 0.6. For four holes discharge coefficient profiles are same as that for single-hole case but it is almost same for diameter ratio of 0.25 and 0.6 as presented in Fig. 15. But in case of nine holes orifice the discharge coefficient increases as diameter ratio decreases (Fig. 16) in steady turbulence region.

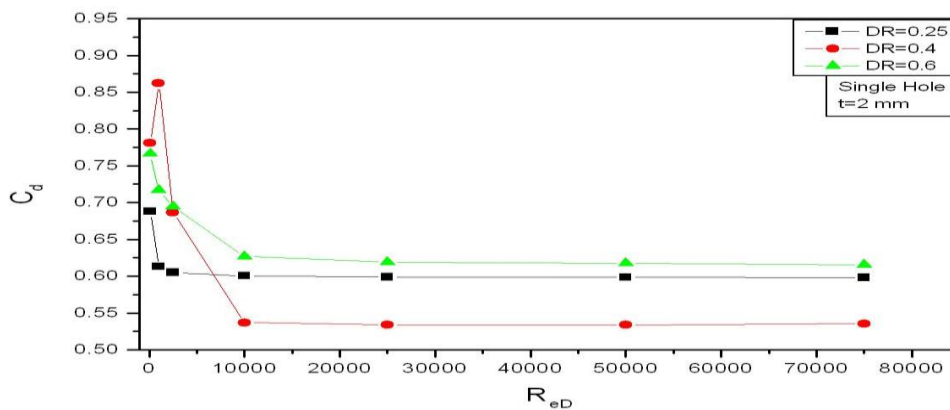

Fig.14 Effect of variation in diameter ratio on discharge coefficient of single-hole.

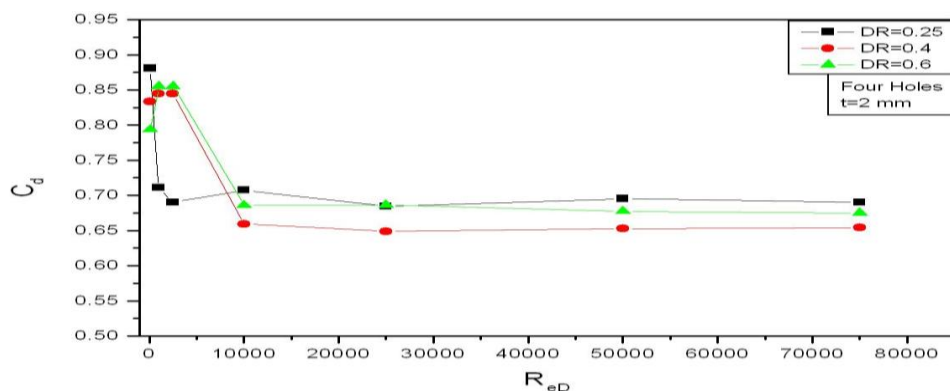

Fig. 15 Effect of variation in diameter ratio on discharge coefficient of four holes.

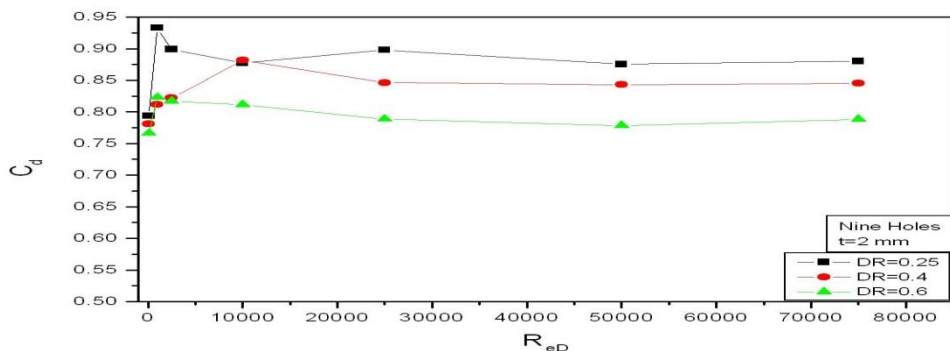

Fig. 16 Effect of variation in diameter ratio on discharge coefficient of nine .

It is reasonable to deduce that the scattering of the discharge coefficient would become serious when the hole number is small enough. For one extreme there is only one hole at the center of the orifice plate corresponding to a standard orifice. For the other extreme, there are too many holes where the friction pressure drop is estimated to be rather high according to equation (10). This is because contracting area between the fluid and the orifice is drastically increasing.

Effect of holes distribution: Even with the same number of holes, thickness, and diameter ratio, the change in hole-distribution over the cross section will have an important impact on the discharge coefficient and differential pressure across orifice. Two orifices, type-2 and type-3, were tested with the same number of holes, diameter ratio and thickness but with different distributions. For the former, eight holes were uniformly distributed over a concentric circle of diameter $d_1=15$ mm (type-2), one hole being at the center of circle, whereas for the latter, four holes were uniformly distributed over the same circle and remaining four holes are distributed over second concentric circle with a diameter of $d_2=10$ mm (type-3).

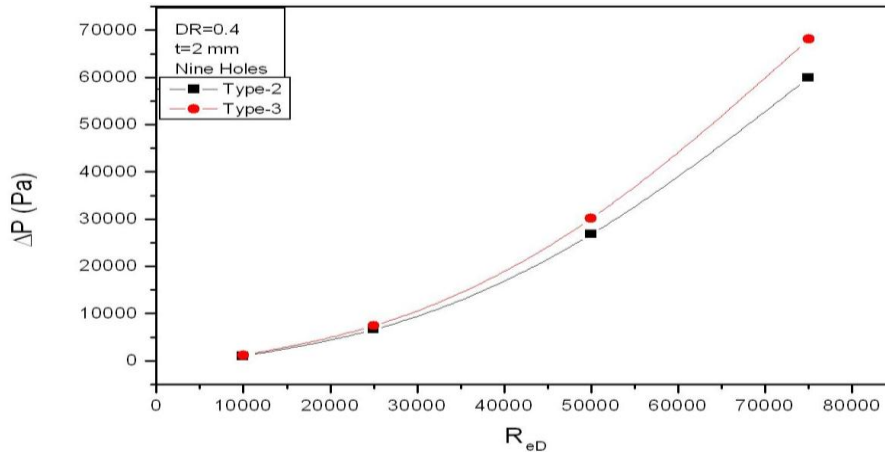

Fig. 17 Effect of change in distribution of holes on the discharge coefficient of nine holes.

For corresponding ΔP shown in Fig. 17, the discharge coefficient (calculated using Eq. 6) decreases for type-3 distributions of orifices by 5.5 to 8.3%, as compared to type-2. The differential pressure across the orifice increases (Fig.17) due to change in distribution of orifices (type-2 as shown in Fig. 4 and type-3 shown in Fig.5) over the cross section of plate from type-2 to type-3. Thus there is a corresponding decrease in C_d . Hence pressure drop decreases in case of change in distribution from type-2 to type-3.

Effect of multi-stage: Two multiple hole orifices with two diameter ratio of 0.4 and 0.6 were tested for two stage along with corresponding single hole orifices. The variation of differential pressure is as shown in Fig.18 and 19, for two different diameter ratios. At the second stage of orifice with diameter ratio, 0.4, the differential pressure decreases with increase in number of holes. This trend is being same for second stage orifice of DR, 0.6. The differential pressure is found to be smaller for multiple holes orifices in multi-stage. In the presented results of analysis the ΔP decreases by 6 to 20 % in multi-stage case as compared to corresponding single-stage orifices.

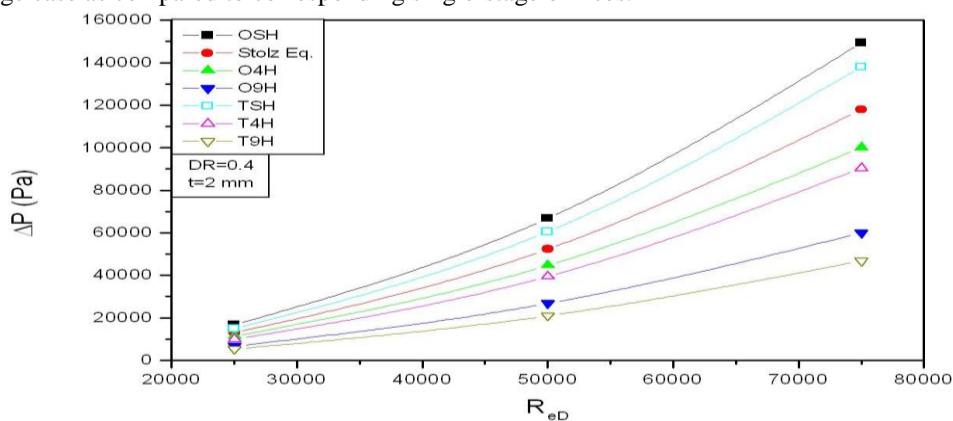

Fig 18 Comparison of variation of differential pressure between single stage and multi stage orifices of DR=0.4.

Thus for multi-stage case the pressure drop increases with increase in number of orifices and stages. Hence corresponding discharge coefficient becomes larger, suggesting that their anti-disturbance ability is better than that of the corresponding standard ones. Mansoor et al. [14] employed a perforated orifice upstream as a conditioner to the flow, and assessed their effects on discharge coefficient.

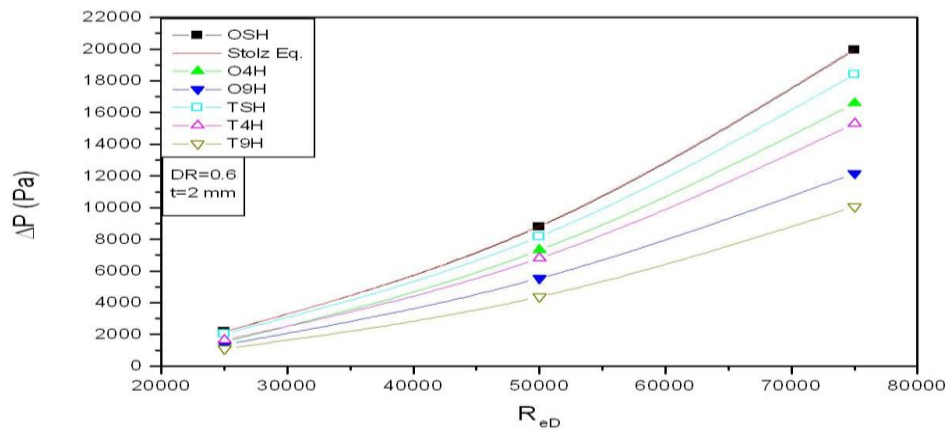

Fig 19 Comparison of variation of differential pressure between single stage and multi stage orifices of DR=0.6.

The results of C_d at first stage of two stage (multi-stage) orifice is found to be same as it across the corresponding orifice in single stage. Thus results of C_d and ΔP already presented for single stage cases are further considered for comparison with corresponding results at second stage of multi-stage case. Thus second stage orifice can be regarded as flow conditioner. The results demonstrated that the discharge coefficient with the conditioner is 4.5% larger than that without it, as considered in reference article [14]. The present work carried out with orifices in two stages. However in the present study the discharge coefficient increase by 3-6%, 4-7% and 10-11% for two stage single, four, and nine hole orifice, respectively with diameter ratio of 0.4 as compared to those orifice in single stage case. For diameter ratio of 0.6 the discharge coefficient increase by 3-4%, 3-4% and 9-11% for two stage single, four, and nine hole orifice respectively for two stage as compared to single stage case.

VI. CONCLUSION

In this article, numerical investigation of discharge coefficient and throttling characteristics were presented in single-phase water flows by varying structural parameters, such as orifice thickness, number of holes, holes distribution, diameter ratio and number of stages. From these results following conclusions may be drawn:

- The pressure drop due to minor friction coefficient determines the performance of differential pressure orifices. In the allowable engineering range, pressure difference should be reduced to obtain a large discharge coefficient with a higher accuracy and a broader application range.
- As numbers of holes increases the discharge coefficient increases with corresponding decrease in differential pressure. We can observe an increase in discharge coefficient with decrease of diameter ratio for more numbers of orifices.
- Pressure difference ΔP across the multiple orifices, increases with a decrease in orifice thickness.
- Results are validated by comparing with Stolz Eq. and Reader-Harris/Gallagher Eq. Numerical results fit well with an error less than 10% for discharge coefficient across the orifice plates.
- The relation between DR and EDR were used to compare available correlations with the test data. This comparison revealed that the test had an acceptable accuracy, as the results fit with correlations using Stolz discharge coefficient model.
- Discharge coefficient across second stage of orifice was larger by 3-5%, 4-6% and 9-11% for single, four, and nine orifices respectively as compared to corresponding single stage.
- There will be decrease of pressure difference in multi-stage orifices by 6 to 20 % as compared to single stage case. Thus corresponding increase in pressure drop across multi-stage orifices.

REFERENCES

- [1] Tianyi Zhao, Jili Zhang and Liangdong Ma. "A general structural design methodology for multi-hole orifices and its experimental application". *Journal of Mechanical science and Technology* 25 (9) (2011) 2237-2246.
- [2] G. H. Gan and S. B. Riffat, "Pressure loss characteristics of orifice and perforated plates", *experimental thermal and fluid science*, 14 (2) (1997) 160-165.
- [3] Dug dale, "viscous flow through a sharp edged orifice". *Institute of journal of engineering science*. 35 (8) (1997), 725-729.
- [4] G. L. Morrison, Dwayne Terracina, Carl Brewer, K. R. Hall (2001), "Response of a slotted orifice flow meter to an air water mixture", *Flow Meas. & Instrum*, 12 (2001) 175-180.
- [5] Y. Geng, J. Zheng, T. Shi, "Study on the metering characteristics of a slotted orifice for wet gas flow", *Flow Meas. Instrum*. 17 (2006) 123-128.



- [6] P. Testud, P. Moussou, A. Hirschberg, Y. Auregan “Noise Generated By Cavitation of Single-Hole and Multi-Hole Orifices in A Water Pipe”, *Journal of fluids and structures*, 23 (2) (2007).
- [7] Shanfang Huang, Taiyi Ma, Zonghu Lin, “Study on discharge coefficient of perforated orifices as a new kind of flowmeter”, *Experimental thermal and fluid science*, 2013, vol. 46, pp. 74-83
- [8] I. E. Idelchik, E. Fried, *Handbook of hydraulic resistance: 2nd edition*, Hemisphere Publishing, New York, 1986.
- [9] J. Stolz, “A universal equation for the calculation of discharge coefficients of orifice plates”, In *Flow Measurement of Fluids* (ed. H.H.Dijstelbergen and E.A.Spencer), North Holland, Amsterdam (1978) 519-534.
- [10] M. J. Reader-Harris, J. A. Sattary and E. P. Spearman, “The orifice plate discharge coefficient equation-future works”. *Flow meas. Instrum.*, 6 (2) (1995) 101-144.
- [11] P. A. Kolodzie Jr., M. Van Winkle, “Discharge coefficient through perforated plates”, *AICE Journal*, 3(1957) 305-312.
- [12] L. F. Moody, “Friction factor for pipe flow”, *Transe. ASME* 66(1944) 671.
- [13] D. D. Joseph, Y. Y. Renardy, “Fundamentals of two-fluid dynamics”, Springer, New York, 1993.
- [14] B. Manshoor, F. Nicolleau, S.Beck, “The fractal flow conditioner for orifice plate flow meters”, *Flow Meas. Instrum.* 22(2011) 208-214.
- [15] Naveenji Arun, S Malavarayan, M Kaushik, “CFD analysis of discharge coefficient during non Newtonian flows through orifice meter” *International Journal of Engineering Science & Technology* 2 (7) (2010) 3151-3164.
- [16] Manish S. Shah, Jyeshtharaj B. Joshi, Avtar S. Kalsi, C.S.R. Prasad, Daya S. Shukla, “Analysis of flow through an orifice meter: CFD simulation”. *Chemical Engineering Science* 71 (26 March 2012) 300-309.
- [17] R K Singh, S N Singh and V Seshadri, “Performance evaluation orifice plate assemblies under non-standard conditions using CFD”. *Indian journal of engineering and materials sciences* 17 (Dec 2010) 397-406.
- [18] Suhas V. Patankar, “Numerical Heat Transfer and Fluid Flow”, Hemisphere Publishing Corporation, McGraw Hill Book Company, 1980.
- [19] Zhao Tian-yi and ZangJi-li, “Experimental investigation of key parameters pertinent to multi-hole orifice throttling characteristic”, *Journal of Harbin Institute of Technology (New Series)*, 15 (1) 2008.